

## 6

Chemical Bonding  
– Orbital Theory

## CHAPTER

## CONTENTS

BOND FORMATION  
VALENCE BOND THEORY  
Nature of Covalent Bond  
Sigma ( $\sigma$ ) Bond  
Pi ( $\pi$ ) Bond

ORBITAL REPRESENTATION OF MOLECULES

CONCEPT OF HYBRIDIZATION

TYPES OF HYBRIDIZATION  
Hybridization involving  $d$  orbitals

HYBRIDIZATION AND SHAPES OF MOLECULES  
 $sp^3$  Hybridization of carbon  
 $sp^2$  Hybridization of carbon  
 $sp$  Hybridization of carbon  
Shape of  $H_2O$  molecule  
Shape of  $PCl_5$  molecule  
Shape of  $SF_6$  molecule

MOLECULAR ORBITAL THEORY  
Linear Combination of Atomic Orbitals (LCAO method)

BOND ORDER

HOMONUCLEAR DIATOMIC MOLECULES  
Hydrogen,  $H_2$   
Lithium,  $Li_2$   
Beryllium,  $Be_2$   
Nitrogen,  $N_2$   
Oxygen,  $O_2$   
Fluorine,  $F_2$

HETERONUCLEAR DIATOMIC MOLECULES  
Nitric Oxide (NO)  
 $NO^+$  and  $NO^-$  ions  
Carbon Monoxide (CO)  
CN Molecule

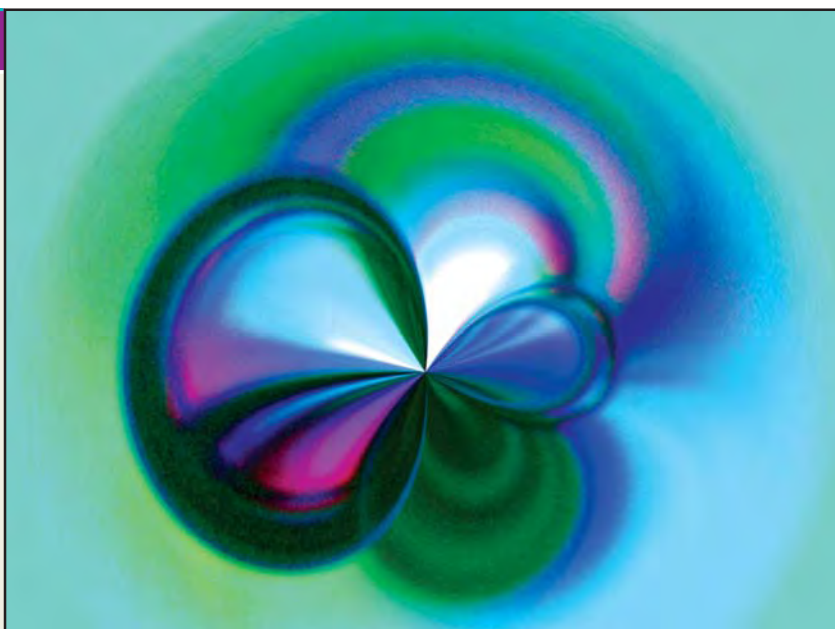

With a knowledge of the electronic structure of atoms and their orbitals as background, we now proceed to discuss the behaviour of atoms when their ‘atomic orbitals’ interact to form chemical bonds.

Free atoms have a random motion and possess energies. Farther the atoms are more will be the energy of the system, giving it lesser stability. Two or more atoms unite to form a molecule because in doing so the energy of the system is lowered and thus the ‘molecule’ becomes stable in comparison to separate atoms. **In other words, a stable chemical union or bond between two (or more) atoms comes into existence only if the energy is lowered when the atoms come in close proximity.**

By the term ‘energy’ here, we mean the sum of the kinetic and potential energies. The kinetic energy of atoms finds its origin in the unabated motion of the electrons. The potential energy of a system in which atoms A and B approach each other can be due to

- Electron-electron repulsions
- Nucleus-nucleus repulsions
- Nucleus-electron attractions.

This is beautifully illustrated by the following diagram (Fig. 6.1).

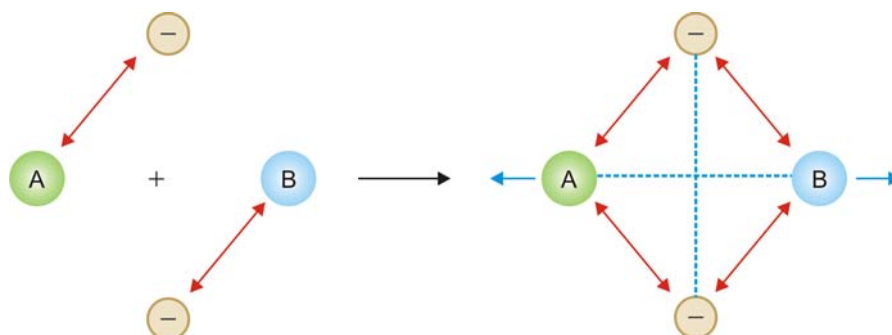

■ **Figure 6.1**  
Illustration of potential energy of the system consisting of approaching atoms A and B; the double headed arrows ( $\leftrightarrow$ ) indicate attraction and dotted lines indicate repulsion.

The kinetic and potential energies of a system are related by the **Virial Theorem** according to which the potential energy (P.E.) is double the kinetic energy (K.E.) and opposite in sign. Putting it mathematically,

$$\text{P.E.} = -2 \text{K.E.} \quad \dots(1)$$

The total energy ( $E$ ) of the system is given as

$$E = \text{P.E.} + \text{K.E.}$$

or

$$E = -2 \text{K.E.} + \text{K.E.} \\ = -\text{K.E.} \quad \dots(2)$$

Also

$$E = \text{P.E.} + \text{K.E.} = \text{P.E.} + \left(-\frac{1}{2} \text{P.E.}\right) \\ = \frac{1}{2} \text{P.E.} \quad \dots(3)$$

If  $E_A$  and  $E_B$  are the energies of the two separated atoms A and B and  $E_{AB}$  the energy of the molecule AB, we have from above

$$E_A = \frac{1}{2} (\text{P.E.})_A$$

$$E_B = \frac{1}{2} (\text{P.E.})_B$$

$$E_{AB} = \frac{1}{2} (\text{P.E.})_{AB}$$

Let us now examine the change in energy ( $\Delta E$ ) as the atoms A and B come together :

$$\Delta E = E_{AB} - (E_A + E_B) \\ = \frac{1}{2} (\text{P.E.})_{AB} - \left[ \frac{1}{2} (\text{P.E.})_A + \frac{1}{2} (\text{P.E.})_B \right]$$

or

$$\Delta E = \frac{1}{2} \Delta \text{P.E.} \quad \dots(4)$$

where  $\Delta E$  is the change in energy of the system. As stated earlier, the change in the energy of the system should be negative in order a stable bond be formed between A and B. In other words, **the net potential energy of the system must decrease as a result of the formation of a chemical bond by**

**electronic rearrangements.** Out of the three factors determining the potential energy, the first two are ‘repulsive’ in nature and, therefore, cannot lower the potential energy in any manner. As the atoms approach each other, the electron-nucleus attractions contribute to the lowering of the potential energy, since each electron is now attracted towards the two positive nuclei at the same time, as compared to one nucleus in the isolated atoms.

### BOND FORMATION (VALENCE BOND THEORY)

Bond formation between atoms to give chemical compounds can be interpreted admirably in terms of the orbital theory of atomic structure. Heitler and London believed that electron cloud of the valence orbital on one atom ‘overlaps’ the electron cloud of the other bonding atom to form a covalent linkage. On the contrary, the electrovalent bond formation involves a physical transfer of the electron and the orbital concept is not very useful for their explanation. The theory of ‘*maximum overlap*’, affords an excellent interpretation of covalent bond formation. The essential conditions for the overlap of electron waves of orbitals are :

(1) **The orbitals entering into combination must have only one electron.**

The orbitals containing a pair of electrons are not capable of combination. In fact, half-filled orbitals on one atom have a tendency to combine with half-filled orbitals on other atom, and the resulting orbital acquires a pair of electrons of opposite spins.

(2) **The atoms with valence or bonding orbital (half-filled) should approach sufficiently close to one another with the axis of their orbitals in proper alignment.**

The strength of a covalent bond depends upon the extent of overlapping. Greater the overlapping between the atomic orbitals stronger is the bond formed between the two atoms.

The new arrangement has lesser energy than the isolated atoms and, is therefore, more stable. The amount of energy given off or released per mole at the time of overlapping of atomic orbitals to form a bond is termed as **Bond Energy** or **Stabilisation Energy**. It also implies that this much energy must be put in to separate the atoms in a molecule.

Since the overlapping of atomic orbitals involves a release of energy, it must produce a stabilizing effect on the system. The merger or overlapping of the atomic orbitals halts at a stage when the atomic nuclei have come close enough to exercise a repulsive force on one another, which exactly balances the force of merger. **This equilibrium distance at which the two atomic nuclei are now held is called the Bond length.**

Bond	Covalent Bond	
	Energy (kcal/mole)	Length $r_c$ (Å)
H – H	103.2	0.74
C – H	98.7	1.10
C – C	83	1.54
C = C	146	1.34
C $\equiv$ C	200	1.20
C – N	70.3	1.52
C – N	148	1.29
C $\equiv$ N	213	1.15
C – O	84	1.43
C = O	177	1.24

In the bond formation, greater the overlap greater is the energy set free, *i.e.*, the higher will be the bond strength. This implies that for a bond to be stronger, greater should be the overlap which in

turn shortens the distance between the nuclei. **A stronger bond has, therefore, a shorter bond length.**

### Formation of $H_2$ molecule

Let us consider the formation of hydrogen molecule ( $H_2$ ) from two isolated H atoms each having an electron in its  $1s$  orbital. When two H atoms approach each other, their  $1s$  orbitals overlap, resulting in the formation of a bigger electron cloud known as *molecular orbital*. This new molecular orbital contains both the electrons. As a result, the two H atoms are held together in the form of Hydrogen molecule (H–H). This overlapping of atomic orbitals of hydrogen atoms is shown in Fig. 6.2.

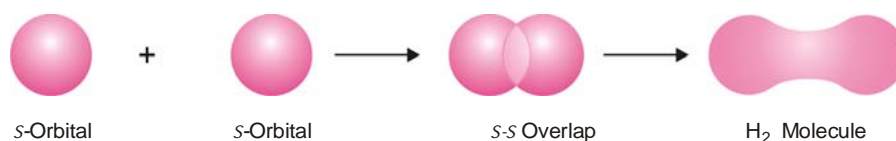

■ **Figure 6.2**  
Formation of  $H_2$  molecules (s-s overlap).

As the two atoms approach closer and closer for the overlap of half-filled  $1s$  orbitals on them, the energy of the system goes on decreasing till it registers a minimum. At this point the overlapping halts, since the positive cores (nuclei) of the two atoms are apart by a certain equilibrium distance, the stabilizing effect of overlapping is completely balanced by the repulsion between the positive nuclei. Beyond this point the energy of repulsion predominates and there is a steep rise in the energy curve with a further decrease of internuclear distance. The point A in the diagram below represents a large value of internuclear distance corresponding to the two isolated atoms. By convention, the energy corresponding to this point is taken to be zero and for stabler systems, the energy of the system is negative. The energy values go on falling as the internuclear distance decreases. At point X on the curve, the internuclear distance decreases and so does the energy value. The minima 'B' represents the point of maximum overlap. The energy value and the internuclear distance corresponding to this point are respectively the bond energy and bond length. For the  $H_2$  molecule, the bond length is  $0.74 \text{ \AA}$  and bond energy is  $103.2 \text{ kcal/mole}$ .

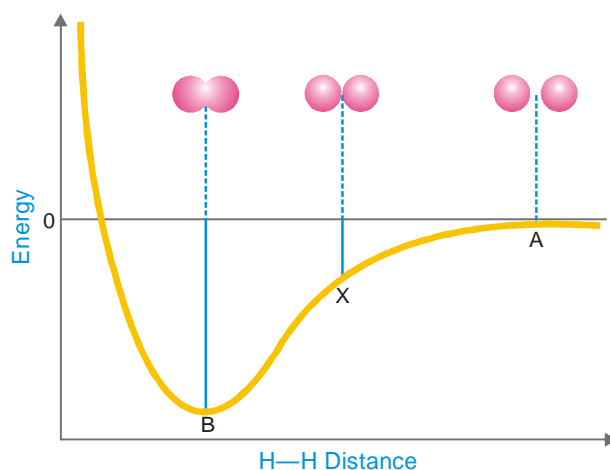

■ **Figure 6.3**  
Energy diagram of s-s overlap.

### Types of overlapping and Nature of Covalent Bond

A covalent bond is of two types depending on the type of overlapping between the two atoms

- (1) Sigma ( $\sigma$ ) bond
- (2) Pi ( $\pi$ ) Bond

#### (1) Sigma ( $\sigma$ ) Bond

When there is end to end overlapping of atomic orbitals along the internuclear axis, the bond resulted is called sigma ( $\sigma$ ) bond. This type of overlapping between the atomic orbitals is also called “head-on” overlapping or “axial” overlapping. It results when one of the following types of overlapping takes place :

##### (a) $s-s$ overlapping

Here  $s$ -orbital of one atom overlaps with the  $s$ -orbital of other atom. An example of this type of overlapping is the formation of hydrogen molecule from two H-atoms.

##### (b) $s-p$ overlapping

In this type of overlap  $s$ -orbital of one atom overlaps with the half filled  $p$ -orbital of the other atom as shown below :



**Examples :** HF, HCl etc.

##### (c) $p-p$ overlapping

Here  $p$ -orbital of one atom overlaps with the  $p$ -orbital of the other atom on internuclear axis. It is shown below :

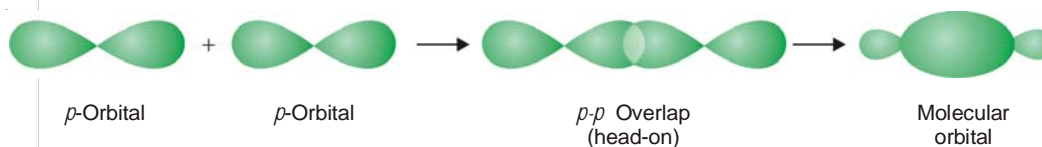

**Examples :**  $F_2$ ,  $Cl_2$ ,  $Br_2$  etc.

#### (2) Pi ( $\pi$ ) Bond

This type of covalent bond is formed by the sidewise overlap of the half filled atomic orbitals. It is also called **lateral** or **sidewise** overlap. This type of overlapping takes place perpendicular to the internuclear axis as shown below :

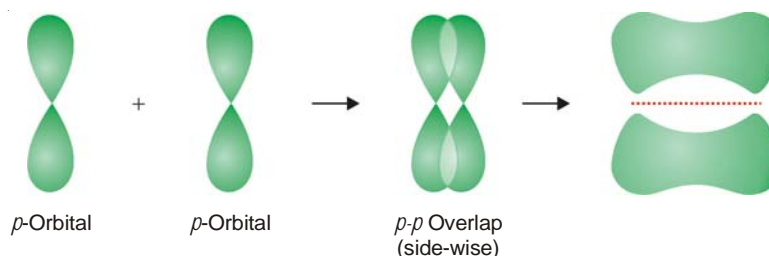

#### Strength of $\sigma$ and $\pi$ bonds

As mentioned earlier, the strength of a covalent bond depends upon the extent of overlapping between the atomic orbitals of participating atoms. During the formation of  $\sigma$  bond the extent of overlapping is more and hence a *Sigma bond is stronger than Pi bond*.

## Differences Between Sigma and Pi bonds

Sigma ( $\sigma$ ) bond	Pi ( $\pi$ ) Bond
1. It is formed by <i>end to end</i> overlapping of half filled atomic orbitals.	1. It is formed by the sidewise overlapping of half filled <i>p</i> -orbitals only.
2. Overlapping takes place along internuclear axis.	2. Overlapping takes place perpendicular to internuclear axis.
3. The extent of overlapping is large and bond formed is <i>stronger</i> .	3. The extent of overlapping is small and bond formed is <i>weaker</i> .
4. The molecular orbital formed as a result of overlapping is symmetrical about the internuclear axis.	4. The molecular orbital formed as a result of overlapping consists of two lobes above and below the internuclear axis.
5. There is free rotation about $\sigma$ bond and no geometrical isomers are possible.	5. There is no free rotation about $\pi$ bond and geometrical isomers are possible.
6. The bond can be present alone.	6. The bond is always formed in addition to sigma ( $\sigma$ ) bond.
7. <i>s</i> and <i>p</i> orbitals can participate in the formation of $\sigma$ bond.	7. Only <i>p</i> -orbitals participate in the formation of $\pi$ bond.

## ORBITAL REPRESENTATION OF MOLECULES

(a) Formation of  $H_2$  molecule

Each hydrogen atom has one electron in  $1s$ -orbital. Two such atoms join to form a molecule of hydrogen. In this case  $s$ - $s$  overlapping between two  $1s$ -orbitals of hydrogen atoms taken place resulting in the formation of hydrogen molecule. There exists a sigma bond between two H-atoms. The situation is represented below :

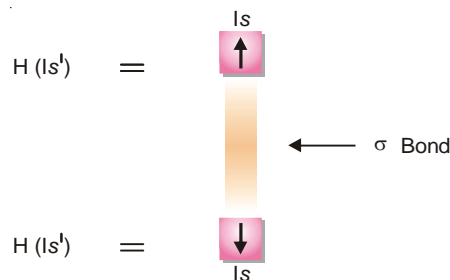
(b) Formation of  $F_2$  molecule

Fluorine (at. no. 9) atom has electron configuration  $1s^2 2s^2 2p_x^2 2p_y^2 2p_z^1$ . The unpaired electron in  $2p_z$  orbital of one atom overlaps with similar orbital of other Fluorine atom along internuclear axis leading to the formation of  $\sigma$  bond.

It is represented as follows :

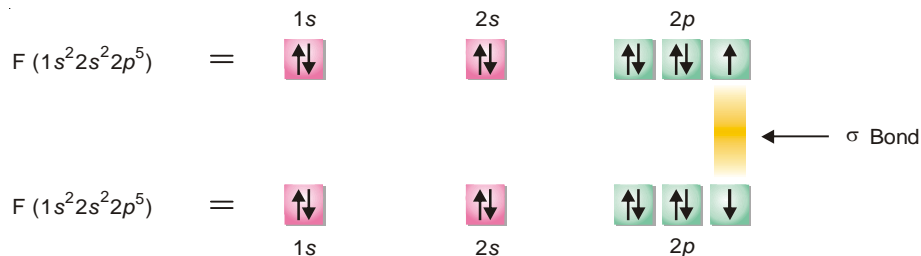

**(c) Formation of HCl molecule**

During the formation of HCl molecule,  $1s$  orbital of Hydrogen atom having an unpaired electron overlaps with  $3p_z$  orbital of chlorine atom having electronic configuration  $1s^2 2s^2 2p^6 3s^2 3p_x^2 3p_y^2 3p_z^1$ . This overlapping takes place along internuclear axis leading to the formation of  $\sigma$  bond as shown below :

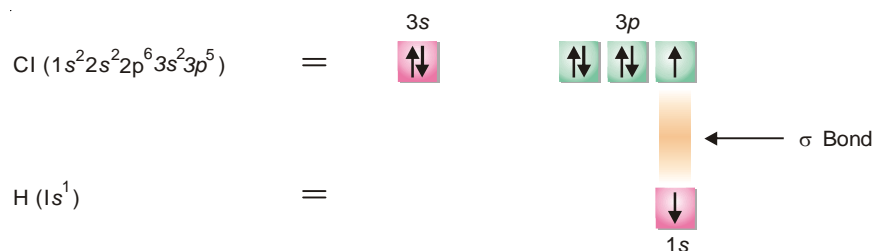
**(d) Formation of Oxygen molecule**

Oxygen (at. no. 8) atom has electronic configuration  $1s^2 2s^2 2p_x^2 2p_y^1 2p_z^1$ . In the formation of  $O_2$  molecule  $2p_z$  orbital of one oxygen atom overlaps with the similar orbital of the other atom along internuclear axis leading to the formation of a sigma ( $\sigma$ ) bond. The other  $2p_y$  orbital of one oxygen atom overlaps with the similar orbital of the another oxygen atom in sidewise manner forming a pi ( $\pi$ ) bond. Thus an oxygen molecule contains a double bond consisting of a sigma ( $\sigma$ ) bond and a pi ( $\pi$ ) bond. The orbital overlap is represented below :

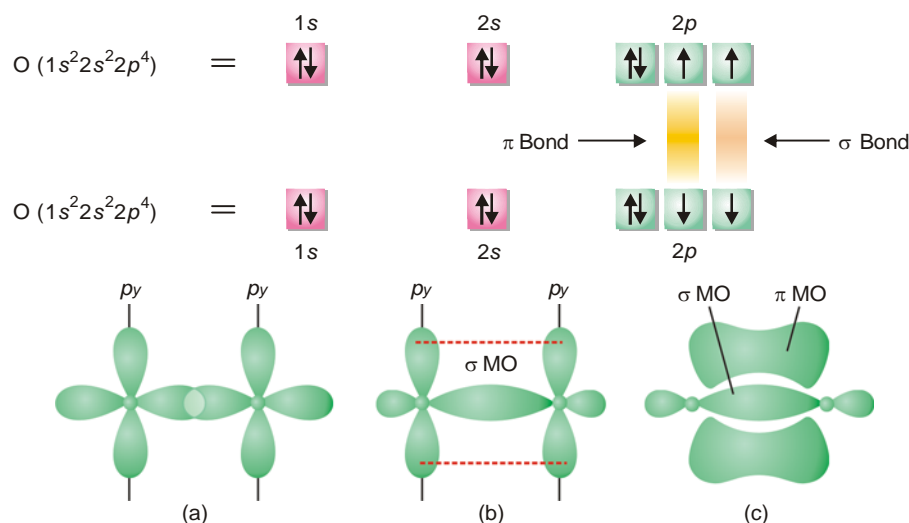

■ **Figure 6.4**

**Schematic overlaps of atomic orbitals of the two oxygen atoms in the formation of  $O_2$  molecule (inner filled orbitals are not shown). (a) represents a head on overlap forming; (b) the  $\sigma$  bond; and (c) represents a  $\pi$  MO enveloping a  $\sigma$  MO.**

**(e) Formation of Nitrogen molecule**

Nitrogen atom has three bonding electrons  $2p_x^1 2p_y^1 2p_z^1$  in its valence shell. These electrons are present in three  $p$ -orbitals which are directed along three axes at right angles. When two N atoms approach each other,  $2p_z$  orbitals overlap in head-on manner to form a sigma ( $\sigma$ ) bond, leaving two sets of parallel  $2p_y$  and  $2p_x$  orbitals. Now the electron clouds in these orbitals interact to produce two pi ( $\pi$ ) bonds by the sidewise overlaps. Thus in  $N_2$  molecule two N atoms are bonded by a triple bond consisting of one sigma ( $\sigma$ ) and two pi ( $\pi$ ) bonds. The orbital overlap in  $N_2$  molecule is shown below:

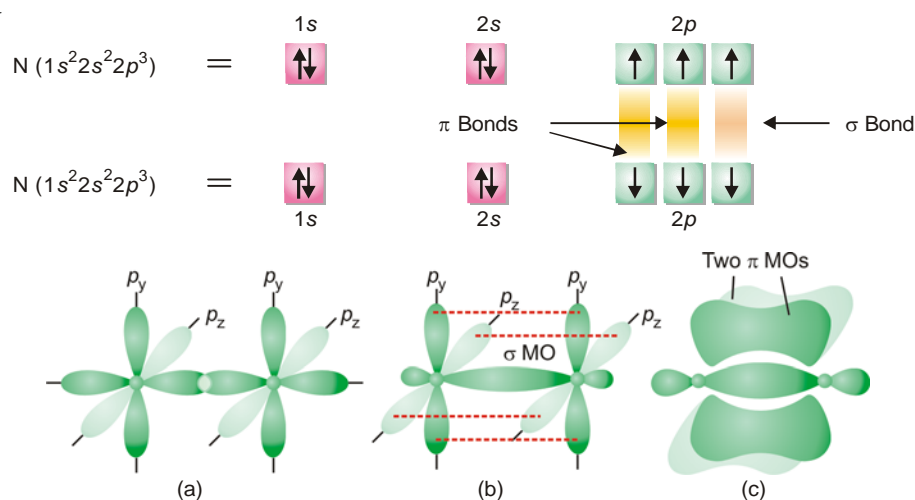
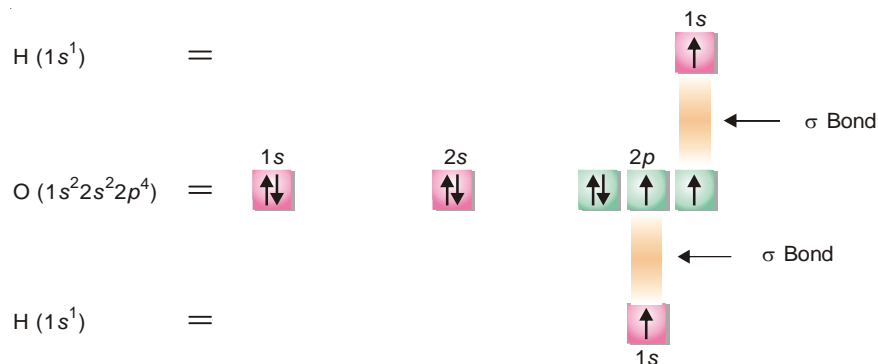

**Figure 6.5** Orbital representation of  $\text{N}_2$  molecule formation; (a) indicates the approach of  $p_x$  orbitals for head on overlap; (b) the formation of  $\sigma$  bond; and (c) the formation of two  $\pi$  MOs by sidewise overlaps.

Thus there is one sigma and two pi bonds in a molecule of nitrogen. It is equivalent to a triple bond in the classical theory.

#### (f) Formation of $\text{H}_2\text{O}$ molecule

Oxygen atom has two half filled orbitals in its second energy shell as its electronic configuration is  $1s^2 2s^2 2p_x^2 2p_y^1 2p_z^1$ . Here  $2p_z$  orbital having an unpaired electron overlaps with  $1s$  orbital of hydrogen forming a sigma ( $\sigma$ ) bond. In a similar way  $2p_y$  orbital of oxygen atom overlaps with  $1s$  orbital of second hydrogen atom forming another sigma ( $\sigma$ ) bond. Thus in  $\text{H}_2\text{O}$  molecule two H atoms are bonded to oxygen atom with sigma ( $\sigma$ ) bonds as shown below :



#### CONCEPT OF HYBRIDIZATION

While formation of simple molecules could be explained adequately by overlap of atomic orbitals, the formation of molecules of Be, B and C present problems of greater magnitude having no solution with the previous theory. To explain fully the tendency of these atoms to form bonds and the shape or geometry of their molecules, a new concept called **Hybridization** is introduced. **According to this concept, we may mix any number of atomic orbitals of an atom, which differ in energy only slightly, to form new orbitals called Hybrid orbitals.** The mixing orbitals generally belong



to the same energy level (say  $2s$  and  $2p$  orbitals may hybridize). The total number of hybrid orbitals formed after mixing, is invariably equal to the number of atomic orbitals mixed or hybridized. An important characteristic of hybrid orbitals is that they are all identical in respect of energy and directional character. They, however, differ from the original atomic orbitals in these respects. They may also differ from one another in respect of their arrangement in space. *i.e.*, orientation. Like pure atomic orbitals, the hybrid orbitals of an atom shall have a maximum of two electrons with opposite spin. Hybrid orbitals of an atom may overlap with other bonding orbitals (pure atomic or hybrid) on other atoms or form molecular orbitals and hence new bonds.

**Thus hybridization may precisely be defined as the phenomenon of mixing up (or merging) of orbitals of an atom of nearly equal energy, giving rise to entirely new orbitals equal in number to the mixing orbitals and having same energy contents and identical shapes.**

### RULES OF HYBRIDIZATION

For hybridization to occur, it is necessary for the atom to satisfy the following conditions :

- (1) **Orbitals on a single atom only would undergo hybridization.**
- (2) **There should be very little difference of energy level between the orbitals mixing to form hybrid orbitals.**
- (3) **Number of hybrid orbitals generated is equal to the number of hybridizing orbitals.**
- (4) **The hybrid orbitals assume the direction of the dominating orbitals.** For example, if  $s$  and  $p$  orbitals are to hybridize, the  $s$  orbital having no directional character, does not contribute towards the direction when  $p$  orbitals determine the directional character of the hybrid orbitals.
- (5) **It is the orbitals that undergo hybridization and not the electrons.** For example, four orbitals of an oxygen atom ( $2s^2, 2p_x^2, 2p_y^1, 2p_z^1$ ) belonging to second level (*i.e.*,  $2s, 2p_x, 2p_y, 2p_z$ ) can hybridize to give four hybrid orbitals, two of which have two electrons each (as before) and the other two have one electron each.
- (6) **The electron waves in hybrid orbitals repel each other and thus tend to be farthest apart.**

### TYPES OF HYBRIDIZATION

Since hybridization lends an entirely new shape and orientation to the valence orbitals of an atom, it holds a significant importance in determining the shape and geometry of the molecules formed from such orbitals. Depending upon the number and nature of the orbitals undergoing hybridization, we have various types of hybrid orbitals. For instance  $s$ ,  $p$ , and  $d$  orbitals of simple atoms may hybridize in the following manner.

#### (a) $sp$ Hybridization

The mixing of an  $s$  and a  $p$  orbital only leads to two hybrid orbitals known as  **$sp$  hybrid orbitals** after the name of an  $s$  and a  $p$  orbital involved in the process of hybridization. The process is called  **$sp$  hybridization**. Each  $sp$  orbital has 50%,  $s$ -character and 50%  $p$ -character. Orbitals thus generated are the seat of electrons which have a tendency to repel and be farther apart. In order to do so the new orbitals arrange themselves along a line and are, therefore, often referred to as **Linear hybrid orbitals**. This gives an angle of  $180^\circ$  between the axes of the two orbitals. It is clear from Fig. 6.6 that an  $sp$  orbital has two lobes (a character of  $p$  orbital) one of which is farther than the corresponding  $s$  or  $p$  orbitals and also protrudes farther along the axis. It is this bigger lobe that involves itself in the process of an overlap with orbitals of other atoms to form bonds. It will be seen later on that the smaller lobes of hybrid orbitals are neglected while considering bond formation.

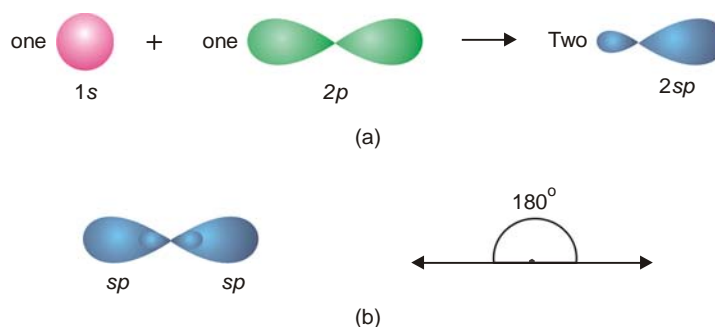

■ **Figure 6.6**  
**(a)  $sp$  Hybridization. (b) Disposition of hybrid orbitals along a line.**

**Examples :**  $\text{BeF}_2$ ,  $\text{BeCl}_2$ , etc.

### (b) $sp^2$ Hybridization

When an  $s$  and two  $p$  orbitals mix up to hybridize, there result three new orbitals called  **$sp^2$  hybrid orbitals** (spoken as ‘ $sp$  two’). Each  $sp^2$  hybrid orbital has 33%  $s$ -character and 67%  $p$ -character. As the three orbitals undergoing hybridization lie in a plane, so do the new orbitals. They have to lie farthest apart in a plane which can happen if they are directed at an angle  $120^\circ$  to one another as shown in Fig. 6.7 (b). It is for this reason that  $sp^2$  hybrid orbitals are also called **Trigonal hybrids**, the process being referred to as **Trigonal hybridization**. The  $sp^2$  hybrid orbitals resemble in shape with that of  $sp$  hybrid orbitals but are slightly fatter.

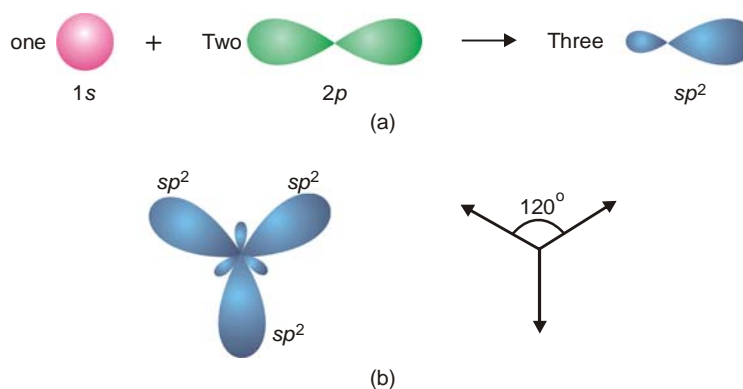

■ **Figure 6.7**  
**(a)  $sp^2$  Hybridization; and (b) Disposition of hybrid orbitals in the same plane at an angle  $120^\circ$  to one another.**

**Examples :**  $\text{BF}_3$ ,  $\text{NO}_3^-$ , etc.

### (c) $sp^3$ Hybridization

The four new orbitals formed by mixing an  $s$  and three  $p$  orbitals of an atom are known as  **$sp^3$  hybrid orbitals**. Each  $sp^3$  hybrid orbital has 25%  $s$ -character and 75%  $p$ -character. Since mixing of orbitals takes place in space, the four hybrid orbital would also lie in space. An arrangement in space that keeps them farthest apart is that of a tetrahedron. Thus each of the four hybrid orbitals are directed towards the four corners of a regular tetrahedron as shown in Fig. 6.8 (b). Because of their tetrahedral disposition, this type of hybridization is also called **Tetrahedral hybridization**. They are of the same shape as that of the previous two types but bigger in size. They are disposed in manner such that the angle between them is  $109.5^\circ$  as shown in Fig. 6.8.

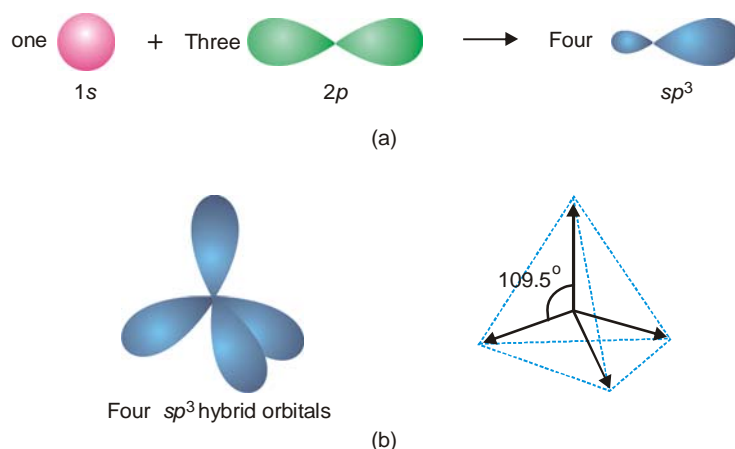

■ **Figure 6.8**

(a)  $sp^3$  Hybridization (b) The four hybrid orbitals are directed towards the four corners of a tetrahedron and are at an angle of  $109.5^\circ$  to one another.

**Examples:**  $\text{CH}_4$ ,  $\text{SO}_4^{2-}$ ,  $\text{ClO}_4^-$ , etc.

#### (d) Hybridization involving $d$ orbitals

There are several types of hybridization involving  $d$  orbitals. Since the  $d$  orbitals have a relatively complex shape, we will consider here only some of the common types. The most important of these are  $sp^3d$  hybridization,  $sp^3d^2$  hybridization and  $sp^2d$  hybridization.

In  **$sp^3d$  hybridization** the orbitals involved are one of  $s$  type, three of  $p$  type and one of  $d$  type. The five new orbitals will be farthest apart by arranging three of them in a plane at an angle of  $120^\circ$  to one another and the other two in a direction perpendicular to the plane. The figure obtained by joining the ends assumes the shape of a trigonal bipyramid (Fig. 6.9). This type of hybridization is, therefore, called **Trigonal bipyramidal hybridization**.

When two  $d$  type of orbitals take part in hybridization with one  $s$  type and three  $p$  type orbitals, **six hybrid orbitals called  $sp^3d^2$  hybrid orbitals** are created. To be away from one another four of them are dispersed in a plane at an angle of  $90^\circ$  each and the rest two are directed up and below this plane in a direction perpendicular to it. On joining their corners, an octahedron results and this type of hybridization also gets the name **Octahedral hybridization** (Fig. 6.9).

So far we have been considering the hybridization of orbitals belonging to the same energy level (say  $3s$ ,  $3p$ , and  $3d$  orbitals) of an atom. But this may not necessarily be so always. In fact, there is very little energy difference between  $3d$ ,  $4s$  and  $4p$  orbitals which may undergo  **$sp^2d$  hybridization**. The  $d$  orbital involved in this type of hybridization has the same planar character as the two  $p$  orbitals have and the hybrid orbitals will also be planar, dispersed in such a way so as to be farthest apart *i.e.*, subtending an angle of  $90^\circ$  between them. This gives a square planar arrangement for them and the hybridization is, therefore, called **Square planar hybridization**.

The directional characters of the types of hybridization discussed above are summarised in Fig. 6.9.

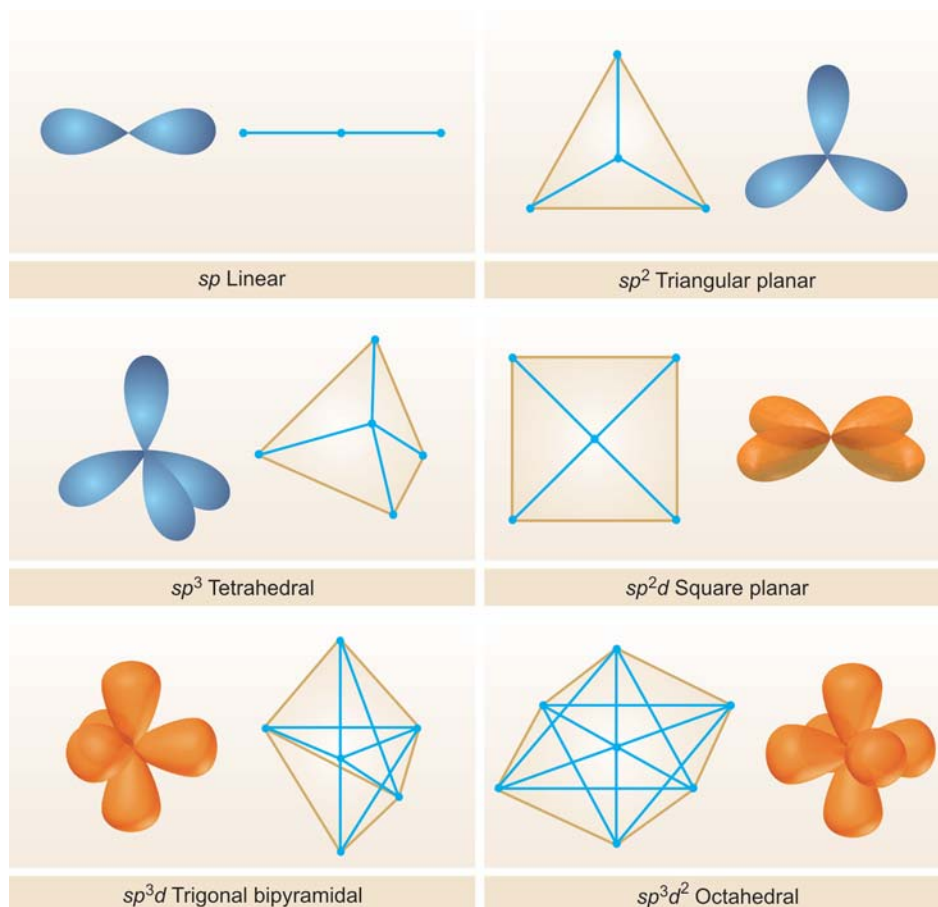

■ **Figure 6.9**  
Directional characteristics of hybrid orbitals.

## HYBRIDIZATION AND SHAPES OF MOLECULES

Diatomic molecules must all be invariably linear but tri- and tetra-atomic molecules have several possible geometrical structures. In this section we will try to arrive at the accepted shapes of some common molecules in the pathway of the popular concept of hybrid orbitals.

### Shape of $\text{BeF}_2$ molecule

An isolated Be atom in its ground state has the electronic configuration  $1s^2, 2s^2$ . At the first thought, one would expect Be to be chemically inert like He since it has all its orbitals completely filled (no bonding orbital). But Be behaves differently because its  $2s$  orbital though complete, possesses another empty  $2p$  level lying in the same shell. This is not so for He ( $1s^2$ ). Since orbitals on the same atom lying very close to one another in energy possess an unusual quality of mixing with one another additively forming new hybrid orbitals, there is ample scope for hybridization here. The Be atom, therefore, gets excited so that one of its  $2s^2$  electrons is 'promoted' to the next available  $2p_x$  orbital before the atom participates in chemical bonding. But this process requires energy which will be available from the heat of reaction released at the time of bond formation. Now the excited atom acquires the structure  $1s^2, 2s^1, 2p_x^1$ . If at this stage the atom forms two bonds by suitable overlaps with two fluorine atoms, these bonds will not be identical, one involving the  $s$  and the other  $p$  orbitals. Thus the  $s$  and  $p$  orbitals first hybridize to form two new and completely equivalent  $sp$  hybrid orbitals. These

hybrid orbitals of Be are now capable of forming bonds. The two  $sp$  hybrid orbitals overlap two  $2p$  orbitals from two fluorine atoms in the ‘head on’ manner to form two  $\sigma$  bonds. The two  $sp$  orbitals being linear, lend a linear shape to  $\text{BeF}_2$  molecule with Be atom lying in the center and two F atoms on its either side so that  $\text{F—Be—F}$  angle is equal to  $180^\circ$  as shown in Fig. 6.10.

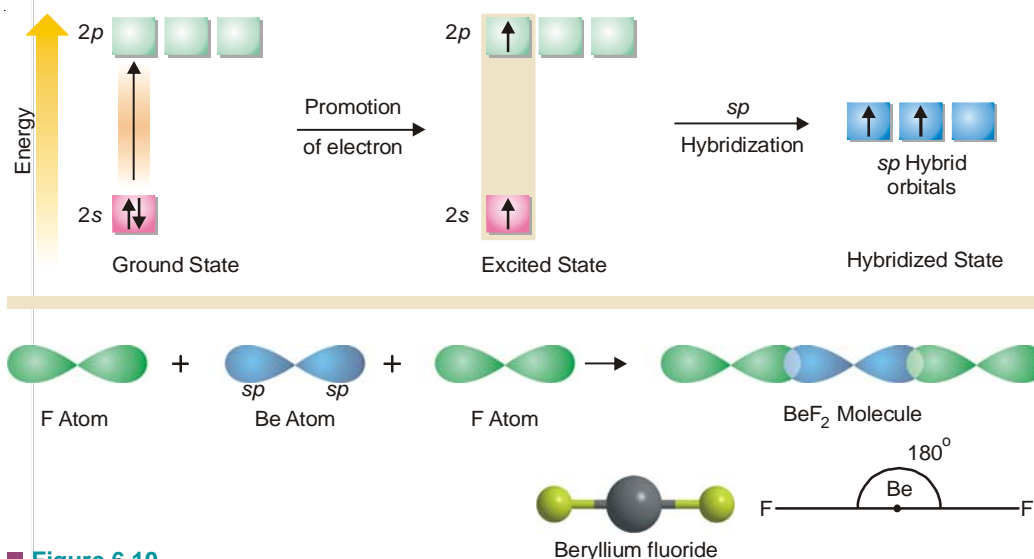

■ **Figure 6.10**

Various states of Be atom. Its orbitals undergo  $sp$  hybridization in the excited state. Overlaps and geometry of  $\text{BeF}_2$  are also shown.

### Shape of $\text{BF}_3$ molecule

The orbital electronic configuration of Boron (B) is  $1s^2, 2s^2, 2p_x^1, 2p_y^0, 2p_z^0$ . As there is only one bonding orbital  $2p_x$ , B is expected to form only one bond. Boron, in fact, is known to form compounds such as  $\text{BCl}_3$ ,  $\text{BF}_3$ ,  $\text{BH}_3$  etc., indicating its capacity to form three bonds. What actually happens is that the two electrons of  $2s$  orbital get unpaired when it is excited just like Be. One of these unpaired electrons thus gets promoted to the vacant  $2p_y$  orbital lying close to it. Thus in the excited state of Boron there are three half-filled orbitals available for bonding. If as such it were to form bonds by overlap, the nature of these bonds would be different owing to their different types. One  $2s$  and two  $2p$  orbitals undergo  $sp^2$  hybridization giving three  $sp^2$  hybrid orbitals lying in one plane *i.e.*,  $xy$ , and subtending an angle  $120^\circ$ . The equivalent hybrid orbitals can now enter into bond formation by overlapping with three  $2p$  orbitals of three fluorine atoms as illustrated in Fig. 6.12. Thus  $\text{BF}_3$  molecule is planar and each  $\text{F—B—F}$  angle is equal to  $120^\circ$ .

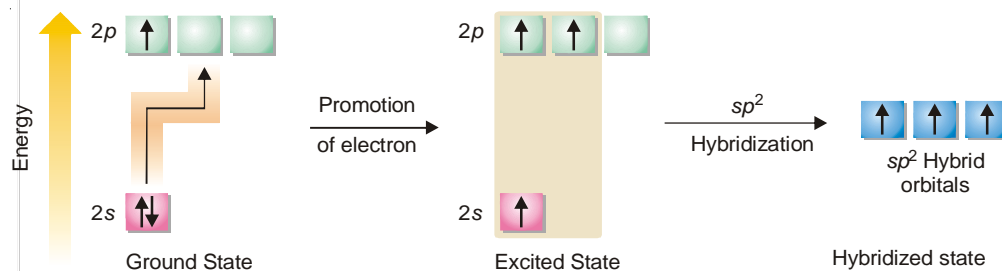

■ **Figure 6.11**

Various states of B atom. The orbitals in the valence shell undergo  $sp^2$  hybridization after excitation of electron.

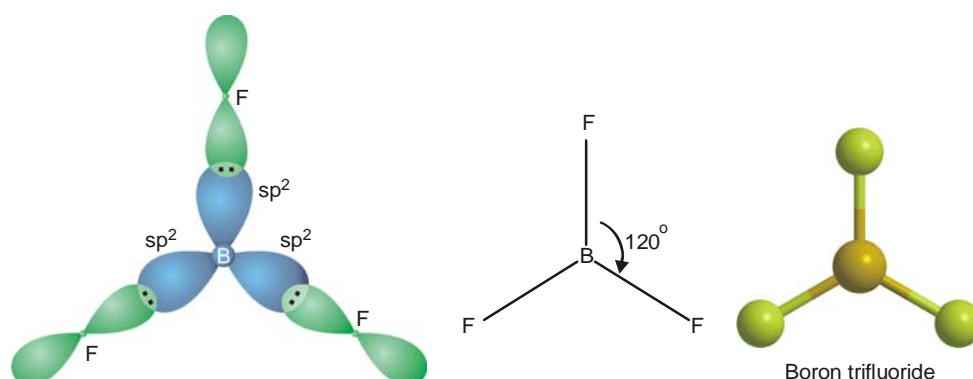

■ **Figure 6.12** Orbital structure and geometry of  $\text{BF}_3$  molecule. The smaller lobes of hybrid orbitals do not enter into bond formation and are not shown.

### SHAPES OF CARBON COMPOUNDS

The carbon atom ( $1s^2, 2s^2, 2p_x^1, 2p_y^1, 2p_z^0$ ) possesses two  $2p$  bonding orbitals *i.e.*,  $2p_x$  and  $2p_y$ , and can be expected to form only two bonds ordinarily. But in common practice we come across compounds of carbon where it behaves as tetra-covalent. To remove the clash between the expected and the actual, the concept of hybridization comes to our rescue. Carbon can undergo three types of hybridization.

#### (a) $sp^3$ Hybridization of Carbon

It is proposed that from  $2s$  orbital, being quite near in energy to  $2p$  orbitals, one electron may be promoted to the vacant  $2p_z$  orbital thus obtaining the excited atom. At this stage the carbon atom undoubtedly has four half-filled orbitals and can form four bonds. But by the strength of the argument extended in case of Be and B, it is assumed that the orbitals of carbon atom first undergo hybridization before forming bonds. In the excited atom all the four valence shell orbitals may mix up to give identical  $sp^3$  hybrid orbitals also four in number. Each of these four  $sp^3$  orbitals possesses one electron and overlaps with  $1s$  orbitals of four H-atoms thus forming four equivalent bonds in methane molecule. Due to the tetrahedral disposition of  $sp^3$  hybrid orbitals, the orbitals are inclined at an angle of  $109.5^\circ$ . Thus all the HCH angles are equal to  $109.5^\circ$ .

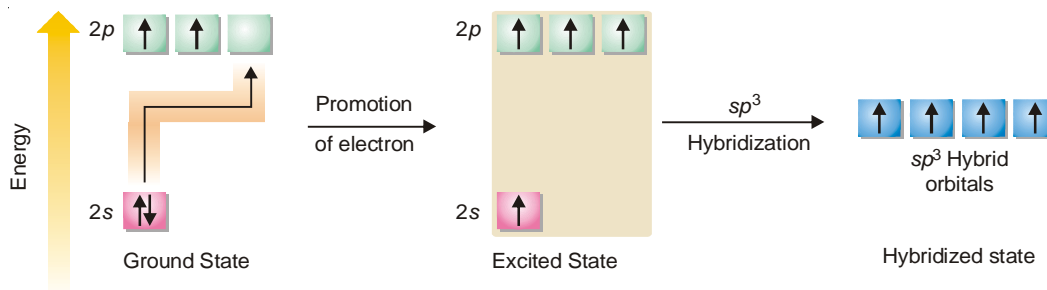

■ **Figure 6.13** Various states of carbon atom; the orbitals here are undergoing  $sp^3$  hybridization.

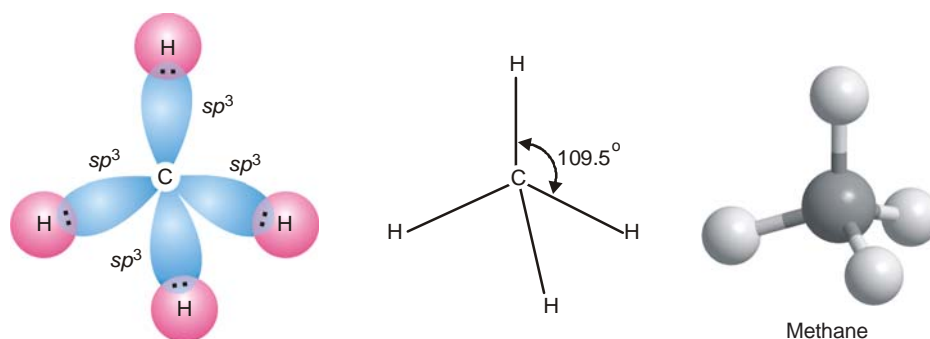

■ **Figure 6.14**  
Shape and formation of methane molecule.

### (b) $sp^2$ Hybridization of Carbon

When three out of the four valence orbitals hybridize, we have three  $sp^2$  hybrid orbitals lying in a plane and inclined at an angle of  $120^\circ$ . If  $2s$ ,  $2p_x$  and  $2p_y$  orbitals of the excited carbon atom are hybridized, the new orbitals lie in the  $xy$  plane while the fourth pure  $2p_z$  orbital lies at right angles to the hybridized orbitals with its two lobes disposed above and below the plane of hybrid orbitals. Two such carbon atoms are involved in the formation of alkenes (compounds having double bonds). In the formation of ethene two carbon atoms (in  $sp^2$  hybridization state) form one sigma bond by 'head-on' overlap of two  $sp^2$  orbitals contributed one each by the two atoms. The remaining two  $sp^2$

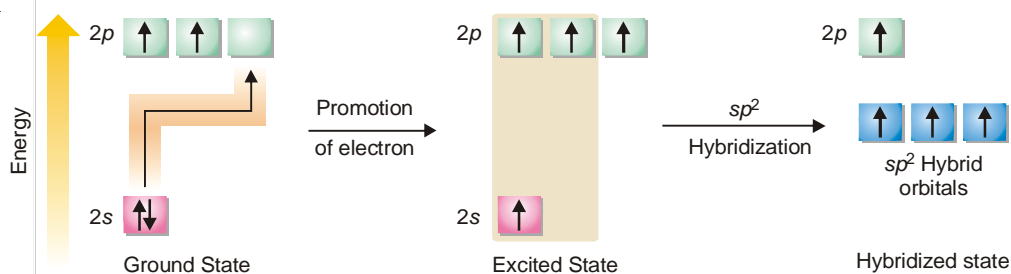

■ **Figure 6.15**  
Excited carbon atom undergoing  $sp^2$  hybridization leaves a pure  $2p_z$  orbital.

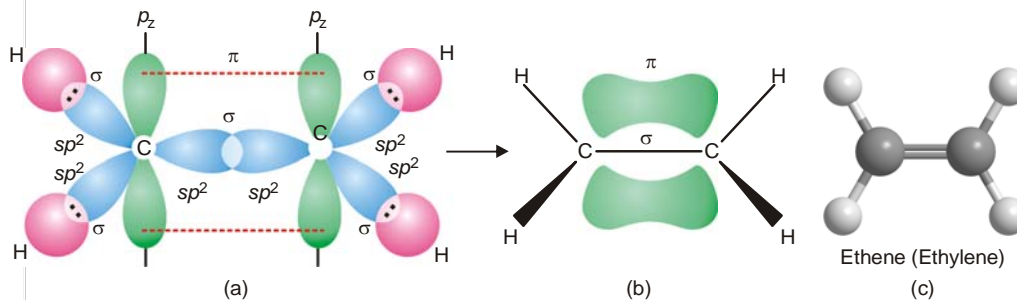

■ **Figure 6.16**  
Orbital model of ethene molecule. (a) shows scheme of overlaps; (b) shows the bonds, sigma bonds indicated by straight lines; and (c) shows ball-and-stick model of ethene (ethylene).

orbitals of each carbon form  $\sigma$  bonds with H atoms. The unhybridized  $2p_z$  orbitals of the two carbon atoms undergo a side-wise overlap forming a  $\pi$  bond. **Thus the carbon to carbon double bond in ethene is made of one  $\sigma$  bond and one  $\pi$  bond.** Since the energy of a  $\pi$  bond is less than that of a  $\sigma$  bond, the two bonds constituting the ethene molecule are not identical in strength. The molecule is a planar one.

### (c) $sp$ Hybridization of Carbon

This type of hybridization is met in alkynes (compounds having a triple bond between two carbons). Here one  $2s$  and only one  $2p$  orbital hybridize to form two equivalent colinear orbitals; the other two  $2p$  orbitals remain undisturbed, both being perpendicular to the axis of hybrid orbitals. One of the two  $sp$  hybrid orbitals on each of the two carbons in ethyne molecule, may be used in forming a  $\sigma$  bond between them. This leaves two pure  $2p$  orbitals ( $2p_y$  and  $2p_z$ ) on each carbon atom. Both these are mutually perpendicular to H–C–C–H nuclear axis, the C–H bonds being formed by overlap of the remaining  $sp$  orbital with  $1s$  orbitals of hydrogens (see Fig. 6.17). These pure  $2p$  orbitals are capable of forming two  $\pi$  bonds by side-wise overlaps.

**Thus ethyne molecule contains one  $\sigma$  and a two  $\pi$  bonds between the two carbons and each carbon is linked with one H-atom through  $\sigma$  bonds.**

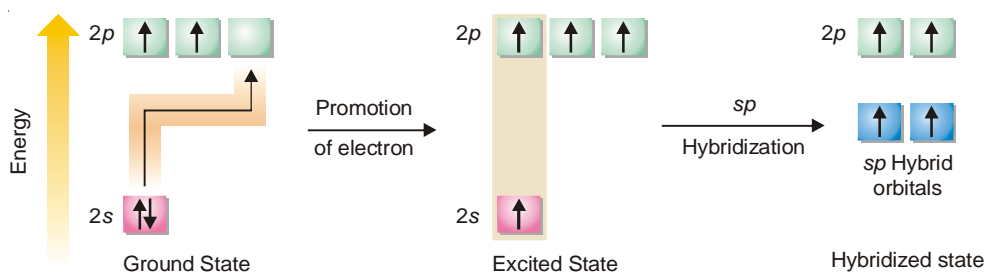

■ **Figure 6.17**  
 $sp$  Hybridization of the orbitals of excited carbon.

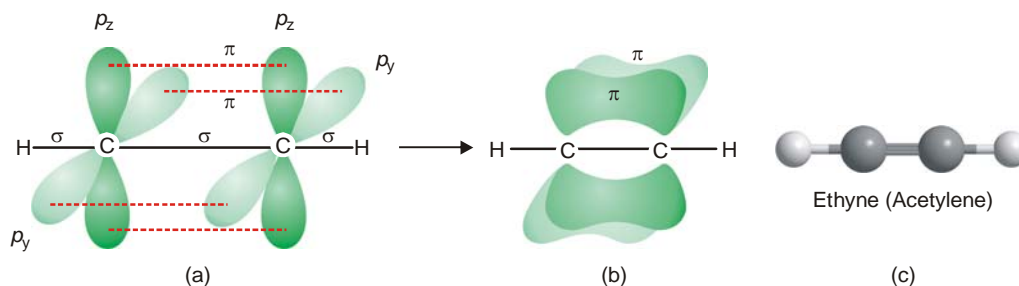

■ **Figure 6.18**  
 Formation of ethyne molecule. (a) shows scheme of overlaps; (b) shows the bonds,  $\sigma$  bonds being indicated by straight lines; and (c) shows ball-and-stick model of ethyne (acetylene)

### Shape of Ammonia molecule, $\text{NH}_3$

There are three  $2p$  bonding orbitals on the nitrogen atom ( $2p_x^1, 2p_y^1, 2p_z^1$ ). It will form three  $\sigma$  bonds by overlap with three  $1s$  orbitals of the three H atoms. The orbital overlaps are shown in Fig. 6.19. The orbital structure of  $\text{NH}_3$  has three orbital overlap axes inclined at an angle of  $90^\circ$  with N-atom as the origin. The four atoms in the molecule of  $\text{NH}_3$  do not lie in the same plane but form a pyramid at whose base are the three H-atoms and the N-atom is at the apex of the pyramid. What we



can predict about the H–N–H bond angles is that they are  $90^\circ$ , the angle between the axes. But this is erroneous and does not agree with the experimental value of  $107^\circ$ . The anomaly can be explained satisfactorily employing (a) the concept of hybrid orbitals and (b) the electron pair interactions.

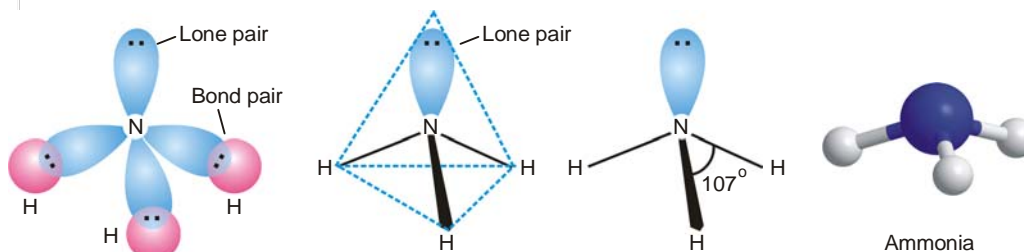

■ **Figure 6.19**  
Orbital overlaps in the formation of ammonia molecule.

### (a) $sp^3$ Hybridization in ammonia molecule

It is assumed that the valence orbitals of the central N-atom undergo hybridization before affecting overlaps with  $1s$  orbitals of hydrogen. When the orbitals of the second energy level of N-atom ( $2s^2$ ,  $2p_x^1$ ,  $2p_y^1$ ,  $2p_z^1$ ) undergo  $sp^3$  hybridization, four new hybrid orbitals result. One of these will have two electrons (like the original atom) and is non-bonding while the other three have one electron each and can form bonds by overlap. Now these hybrid orbitals are tetrahedrally dispersed with an angle of  $109.5^\circ$  between them. After hybridization, let the  $1s$  orbitals of three H-atoms overlap to form three  $\sigma$  bonds (Fig. 6.21a). The tetrahedral angle  $109.5^\circ$  is quite near the experimental value  $107^\circ$ , and a difference of  $2.5^\circ$  can be explained by taking into consideration the electron pair interactions.

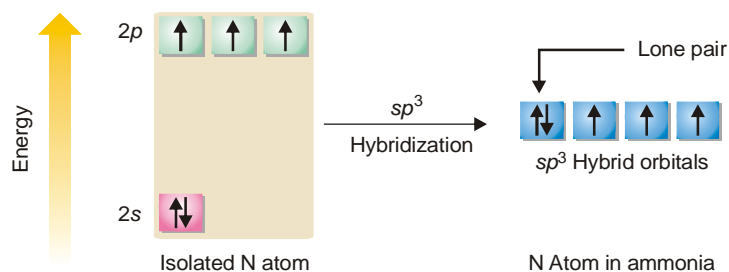

■ **Figure 6.20**  
 $sp^3$  Hybridization of valence orbitals of N-atom.

### (b) Electron pair repulsion

We have seen that the symmetrical central N-atom has in its valence shell, three bond pairs ( $bp$ ), each shared with one of the three H-atoms, and also a lone pair ( $lp$ ) of electrons. The three bond pairs and one lone pair may get arranged tetrahedrally about the central atom. The central atom exercises different pulls on them. The lone pair is attracted more towards the N-atom than the bond pairs which belongs to the H-atoms and N-atom jointly. This is because of the fact that the lone pair belongs *only* to the N-atom and hence its electron cloud is more concentrated near the N-atom. The lone pair is, therefore, capable of exerting a greater repulsion on a bond pair than a bond pair can repel another bond pair. As a result three bonds of ammonia molecule are forced slightly closer than in the normal tetrahedral arrangement. Therefore each of the HNH bond angles is  $107^\circ$  rather than the anticipated

tetrahedral angle of  $109.5^\circ$ . It is also clear from the above reasoning that **more the number of lone pairs greater will be their influence in decreasing the bond angles.**

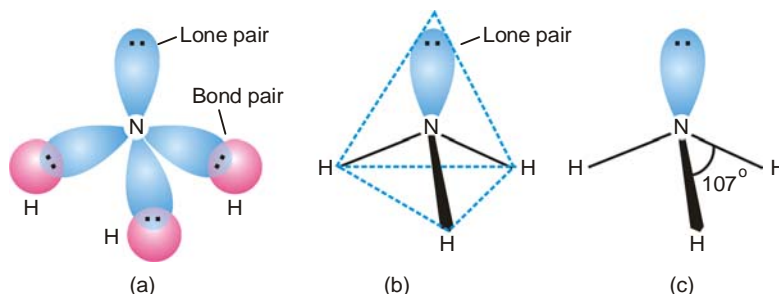

■ **Figure 6.21**  
**(a) Tetrahedral ammonia molecule ( $\text{NH}_3$ ) with a lone-pair orbital in the vicinity of N-atom. (b) Tetrahedral geometry of  $\text{NH}_3$ . (c) Electron pair repulsions :  $lp-bp$  repulsions are greater than  $bp-bp$  repulsions.**

### Shape of Water molecule, $\text{H}_2\text{O}$

In the central oxygen atom of the molecule, there are two bonding orbitals ( $2p_y^1$  and  $2p_z^1$ ). These may overlap with  $1s$  orbitals of two atoms of opposite spins. Each of these two overlaps results in the formation of a  $\sigma$  MO, giving two  $\sigma$  bonds in the molecule as a whole. The pictorial representation of the orbital overlaps is shown in Fig. 6.23. Since the molecule involves two  $2p$  orbitals at right angles and the bond established by an orbital retains the directional character of the

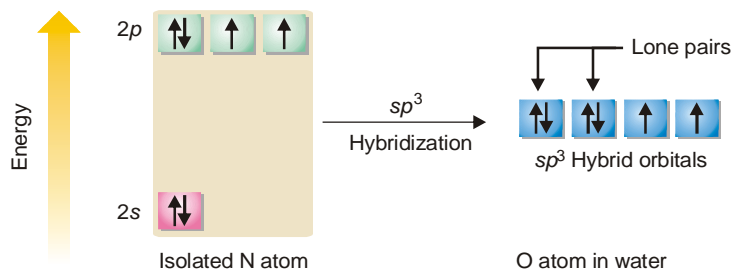

■ **Figure 6.22**  
 **$sp^3$  Hybridization of orbitals of oxygen atom.**

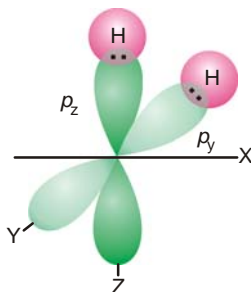

■ **Figure 6.23**  
**Overlap of  $2p_y$  and  $2p_z$  orbitals of O-atom with  $1s$  orbitals of two H-atoms.**

bonding orbital, it is reasonable to expect the bond angle to be equal to  $90^\circ$ . But careful experiments reveal the HOH angle to be  $104.3^\circ$  rather than the predicted  $90^\circ$ . The discrepancy between the

expected and the experimental values of the bond angle is best explained with the help of hybridization concept. The valence orbitals *i.e.*, of the second energy shell of oxygen atom all hybridize giving four tetrahedrally dispersed  $sp^3$  hybrid orbitals. Two of these four hybrid orbitals have pairs of electrons with opposite spins and are non-bonding, while the rest two having one electron each are capable of bonding. They do so by overlaps with orbitals of two H atoms. An adequate guess of the HOH angle would be  $109.5^\circ$ , tetrahedral angle (Fig. 6.24 *a* & *b*). This is certainly in better agreement with the experimental value of  $104.3^\circ$  than our earlier contention of  $90^\circ$  on the basis of pure  $2p$  orbital overlaps. But this is not all. The lone pair-bond pair repulsions have also to play their role. In water molecule there are two lone pairs in the vicinity of the central O-atom which has two bond pairs also. The repulsive forces operating are shown in Fig. 6.24 (*c*) above. Here we would expect the two lone pairs to repel each other more strongly than do a lone pair and a bond pair, and of course, even more strongly than two bond pairs. As a result, the two lone pairs of water force the two (O–H) bond pairs closer together than the one lone pair in case of ammonia forces together the three (N–H) bond pair. Thus the HOH angle is smaller ( $104.3^\circ$ ) than the HNH bond angles of  $107^\circ$ . In the light of the above discussions we can explain the molecular geometry of  $\text{PH}_3$ ,  $\text{PCl}_3$ ,  $\text{NF}_3$ ,  $\text{H}_2\text{S}$ , etc.

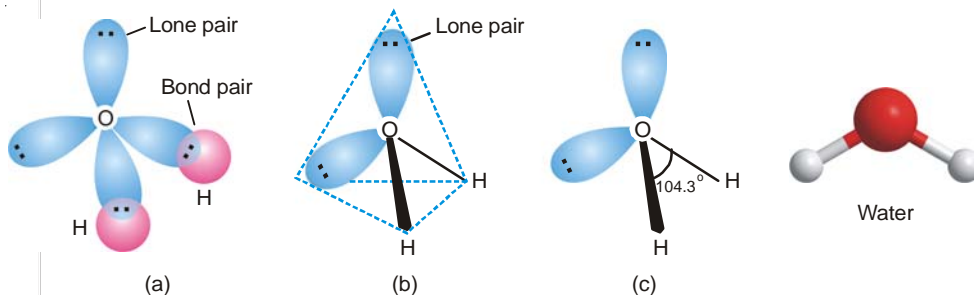

■ **Figure 6.24**  
Tetrahedral model of water molecule showing two lone pairs on O-atom; (c) shows  $bp$ - $bp$ ,  $lp$ - $bp$  and  $lp$ - $lp$  repulsions.

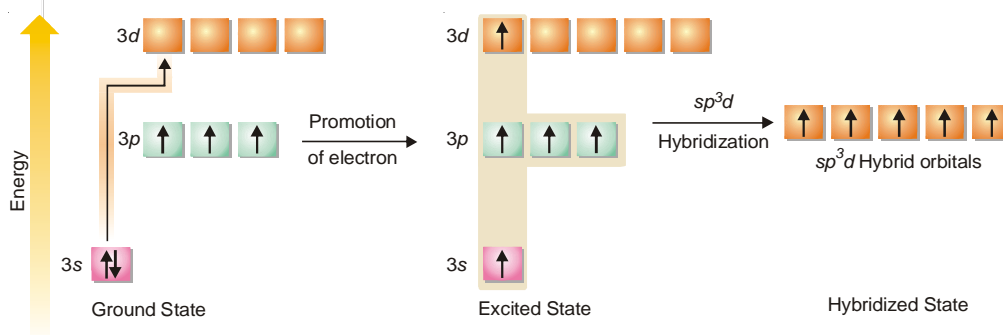

■ **Figure 6.25**  
Various states of Phosphorus atom with its orbitals undergoing  $sp^3d$  hybridization.

### Shape of Phosphorus pentachloride molecule, $\text{PCl}_5$

In  $\text{PCl}_5$  molecule, phosphorus is the central atom which has the electronic configuration  $1s^2, 2s^2, 2p^6, 3s^2, 3p^3, 3d^0$ . In the ground state, it has only three bonding orbitals in the valence shell. One of the two  $3s$  electrons uncouples itself and is promoted to the  $3d$  orbital. The orbitals now hybridize in accordance with  $sp^3d$  type as follows. Three of these five bonding orbitals

lie in a plane inclined at an angle of  $120^\circ$ , while the other two are directed above and below the plane in a direction perpendicular to the plane, taking the shape of a trigonal bipyramid. These orbitals of phosphorus atom can overlap with those of five chlorine atoms forming the  $\text{PCl}_5$  molecule which will therefore have trigonal bipyramidal shape as shown in Fig. 6.26. Here, some of the bond angles are  $90^\circ$  while other bonds have an angle of  $120^\circ$  between them. This geometry of the molecule explains high reactivity of two of the five Cl atoms in  $\text{PCl}_5$  molecule.

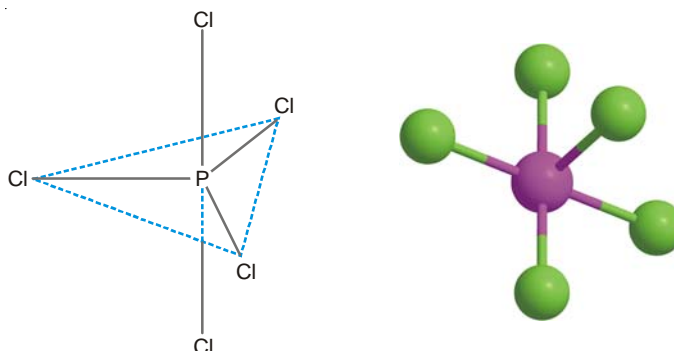

■ **Figure 6.26.**  
 $\text{PCl}_5$  molecule formed by  $sp^3d$  hybridization.

### Shape of Sulphur hexafluoride molecule, $\text{SF}_6$

The sulphur atom has the electronic configuration  $1s^2, 2s^2, 2p^6, 3s^2, 3p^4, 3d^0$ , showing the existence of only two bonding orbitals  $3p_y$  and  $3p_z$ . But sulphur is known to be hexavalent which may be explained by promoting one electron each from  $3s$  and  $3p$  orbitals to the vacant  $d$  orbitals of the valence shell. The orbitals of the excited atom then undergo  $sp^3d^2$  hybridization to produce six equivalent hybrid orbitals each having one electron. These hybrid orbitals are now available for the overlap after getting octahedrally dispersed (four of them lying in one plane inclined at an angle of  $90^\circ$  while the other two directed above and below the plane perpendicularly). Six fluorine atoms (each having one  $2p^1$  bonding orbital) may approach at the corners of the regular octahedron for overlap. The molecule  $\text{SF}_6$  formed will thus have octahedral structure as shown in Fig. 6.28.

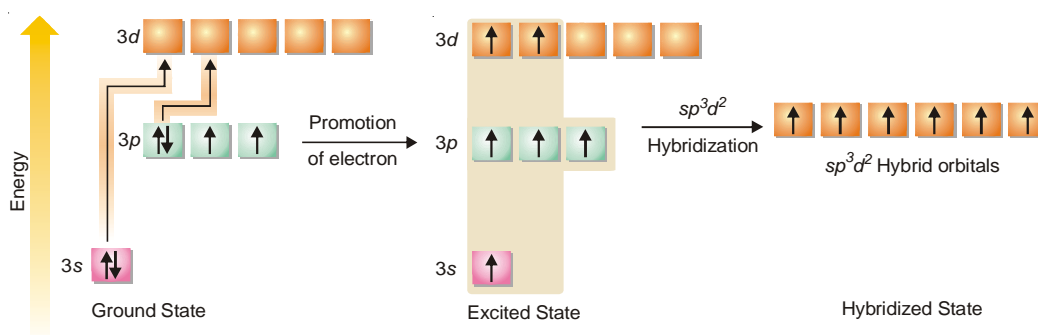

■ **Figure 6.27**  
Various states of sulphur atom, the orbitals of the excited atom undergo  $sp^3d^2$  hybridization.

### Limitations of Valence Bond Theory

Valence Bond theory proposed by Heitler and London in 1927 explains the bonding in simple molecules. According to this theory a covalent bond is formed by the sharing of electron between

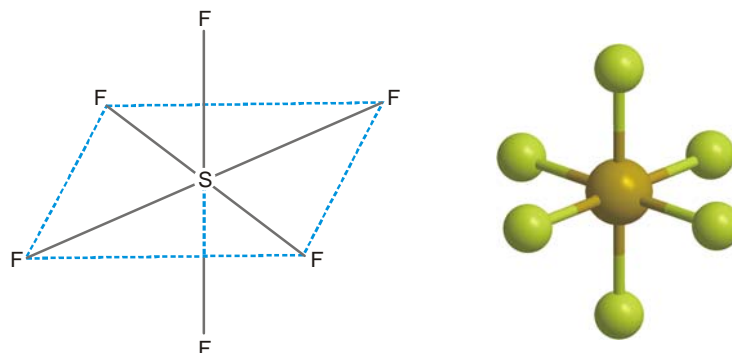

■ **Figure 6.28**  
Formation of  $\text{SF}_6$  molecule by  $sp^3d^2$  hybridization.

the participating atoms. This results if the overlapping between the half filled atomic orbitals takes place and the strength of the bond formed depends upon the extent of overlapping between the atomic orbitals of two atoms. Though the valence bond theory explains the geometry of many molecules and ions yet it has following limitations :

- (1) The presence of other nuclei should affect the electronic arrangement of all the atoms in the molecule
- (2) Sometimes a single electronic structure does not explain all known properties of that molecule or ion and we have the many electronic structures called resonating structures.
- (3) Valence Bond theory fails to explain the bonding in electron deficient compounds.
- (4) It fails to explain the paramagnetic character of oxygen molecule.

### MOLECULAR ORBITAL THEORY

Molecular orbital theory proposed by Hund and Mulliken in 1932 explains the formation of a covalent bond in a better way. According to molecular orbital theory all atomic orbitals of the atoms participating in molecule formation get disturbed when the concerned nuclei approach nearer. They all get mixed up to give rise to an equivalent number of new orbitals that belong to the molecule now. These are called *molecular orbitals*. Thus every molecule is supposed to have molecular orbitals associated with it in much the same way as a single isolated atom has. The main features of molecular orbital theory can be summed up as follows :

- (1) A molecule is quite different from its constituent atoms. All the electrons belongs to the constituent atom and are considered to be moving under the influence of all nuclei.
- (2) Atomic orbitals of individual atoms combine to form molecular orbitals and these MOs are filled up in the same way as atomic orbitals are formed. In other words, Pauli's exclusion principle, Aufbau principle and Hund's rule of maximum multiplicity are followed.
- (3) The molecular orbitals have definite energy levels.
- (4) The shapes of MOs formed depend upon the shape of combining atomic orbitals.

### Linear Combination of Atomic orbitals (LCAO method)

According to wave mechanics the atomic orbitals can be expressed as wave functions ( $\psi_s$ ) which represent the amplitude of electron waves. Their values can be calculated from the solutions of Schrödinger's wave equation. In a similar way, Schrödinger's wave equation can be applied to molecules but with slight difficulty. To cope with the difficulty an approximate method known as Linear Combination of atomic orbitals is applied.

According to this method, the molecular orbitals are formed by the linear combination (addition or subtraction) of atomic orbitals of the constituent atoms of the molecule. Let us consider the simplest case of  $H_2$  molecule consisting of two hydrogen atoms represented by  $H_A$  and  $H_B$ . The atomic orbitals of these atoms are represented by the wave functions  $\psi_A$  and  $\psi_B$ . When these atoms approach each other there come two possibilities.

(1) Molecular orbital is formed by the **addition** of wave functions of atomic orbitals. It can be represented by

$$\psi_{(MO)} = \psi_A + \psi_B \quad \dots(i)$$

The M.O. formed is called **bonding molecular orbital**. It lowers the energy and brings about the stability in the system.

(2) Molecular orbital is formed by the **subtraction** of wave functions of atomic orbitals. It can be represented by

$$\psi_{(MO)}^* = \psi_A - \psi_B \quad \dots(ii)$$

The MO formed is called **antibonding molecular orbital**. This type of MO corresponds to higher energy state. It has net disruptive effect. That is why this MO is termed as antibonding molecular orbital, distinguished by attaching an asterisk (\*) mark with the symbolic name of the molecular orbital. The molecular orbitals formed by the combination of  $1s$  orbitals of two hydrogen atoms is shown below :

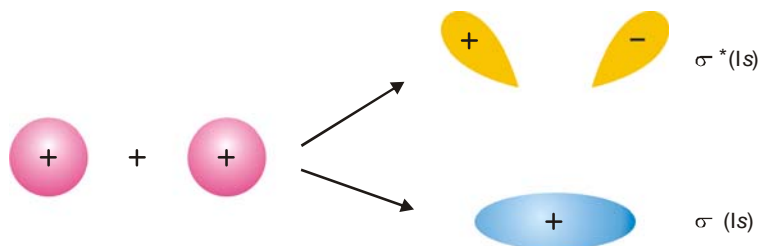

■ **Figure 6.29**  
Formation of molecular orbitals from two  $1s$  orbitals of hydrogen atoms.

The wave functions either have (+) or (-) sign. The positive sign shown on  $1s$  orbitals of hydrogen atoms shows that these orbitals are spherically symmetrical and their wave functions are associated with +ve sign in all directions. In case of  $p$ -orbitals one lobe has +ve sign while other has -ve sign. The overlapping of atomic orbitals takes place if they have similar signs on their lobes.

The probability density in bonding and antibonding molecular orbitals is given by the square of the wave functions shown in the equations (i) and (ii)

$$\begin{aligned} \psi_{(MO)}^2 &= (\psi_A + \psi_B)^2 \\ &= \psi_A^2 + \psi_B^2 + 2\psi_A\psi_B \end{aligned} \quad \dots(iii)$$

$$\begin{aligned} \text{and} \quad \psi_{(MO)}^{*2} &= (\psi_A - \psi_B)^2 \\ &= \psi_A^2 + \psi_B^2 - 2\psi_A\psi_B \end{aligned} \quad \dots(iv)$$

From equation (iii) it is clear that probability density of bonding molecular orbital is greater than the sum of the probability densities of isolated atoms by the factor  $2\psi_A\psi_B$ . Thus the probability density of electrons in bonding MO is greater than that in either of atomic orbitals ( $\psi_A^2$  or  $\psi_B^2$ ).

From equation (iv) it is clear that probability density of antibonding MO is lesser than the sum of probability densities of isolated atoms by a factor  $2\psi_A\psi_B$ . Thus the probability density of electrons in antibonding MO is less than that in either of atomic orbitals ( $\psi_A^2$  or  $\psi_B^2$ ). In a similar way, the combination of two  $2s$  orbitals produces a bonding  $\sigma(2s)$  and antibonding  $\sigma^*(2s)$  molecular orbitals.

### Relative Energies of bonding and antibonding MOs

We have seen above that when atomic orbitals combine, an equivalent number of new orbitals is formed. For example, when two  $1s$  orbitals combine two new molecular orbitals are formed. One of these pertains to the bonding molecular orbital with lower energy while the other corresponds to higher energy as compared to both the atomic orbitals concerned in the process. Thus we find that the number of molecular orbitals formed from atomic orbitals is equal to the number of atomic orbitals responsible for their formation and are of two types as shown below. (Fig. 6.30)

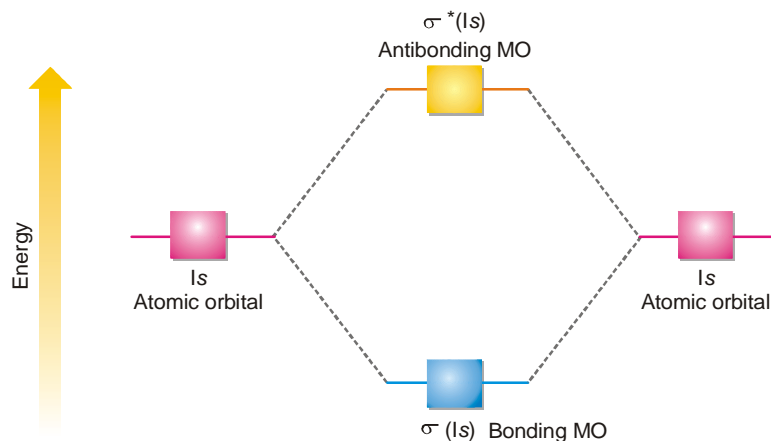

■ **Figure 6.30**  
Energy level diagram for bonding and antibonding molecular orbitals arising from  $1s$  atomic orbital.

### Molecular Orbitals from p-Atomic Orbitals

Combination of  $p$ -orbitals is slightly complicated. There being three types of  $2p$  orbitals namely  $2p_x$ ,  $2p_y$  and  $2p_z$  directed along the cartesian co-ordinates  $x$ ,  $y$  and  $z$  respectively. By convention we assume that  $z$ -axis is the intermolecular axis.

#### (1) Combination of $2p_z$ atomic orbitals

When two  $2p_z$  orbitals on two atoms approach each other along the internuclear axis they combine by the addition of electron wave. This results in the formation of bonding  $\sigma(2p_z)$  orbital while subtraction of electron waves give rise to antibonding molecular orbital  $\sigma^*(2p_z)$ . It is represented as follows :

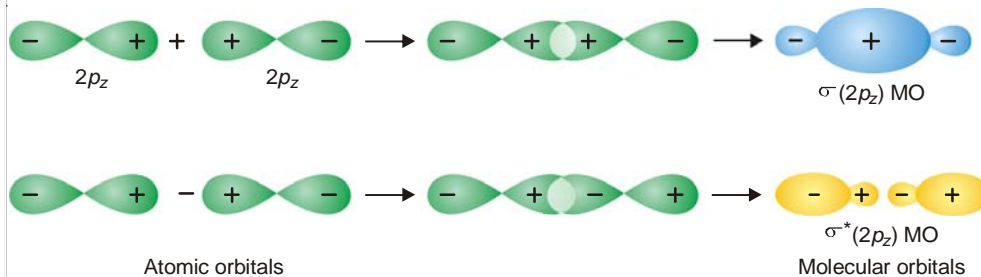

■ **Figure 6.31**  
Combination of  $2p_z$  orbitals to form bonding  $\sigma(2p_z)$  and antibonding  $\sigma^*(2p_z)$  molecular orbitals.

(2) Combination of  $2p_y$  and  $2p_x$  atomic orbitals

When two  $2p_y$  or  $2p_x$  orbitals on two atoms are approaching in a manner that their axes are mutually parallel, they interact to give rise to the formation of molecular orbitals that are not symmetrical about the internuclear axis and are called molecular orbitals represented by  $\pi(2p_y)$  or  $\pi(2p_x)$  bonding orbitals. These  $\pi(2p_y)$  and  $\pi(2p_x)$  bonding MOs have zero electron density on the plane that contains the nuclear axis (nodal plane), while the electron density is concentrated in two regions above and below the nodal plane. The  $\pi^*(2p_y)$  and  $\pi^*(2p_x)$  antibonding MOs have higher energy than their corresponding molecular and atomic orbitals. Since  $2p_y$  and  $2p_x$  atomic orbitals on an atom are degenerate (are of equal energy), the  $\pi$  molecular orbitals arising out of them will also be degenerate *i.e.*  $\pi(2p_y)$  and  $\pi(2p_x)$  bonding molecular orbitals possess equal energy and the same situation prevails in antibonding molecular orbitals  $\pi^*(2p_y)$  and  $\pi^*(2p_x)$ .

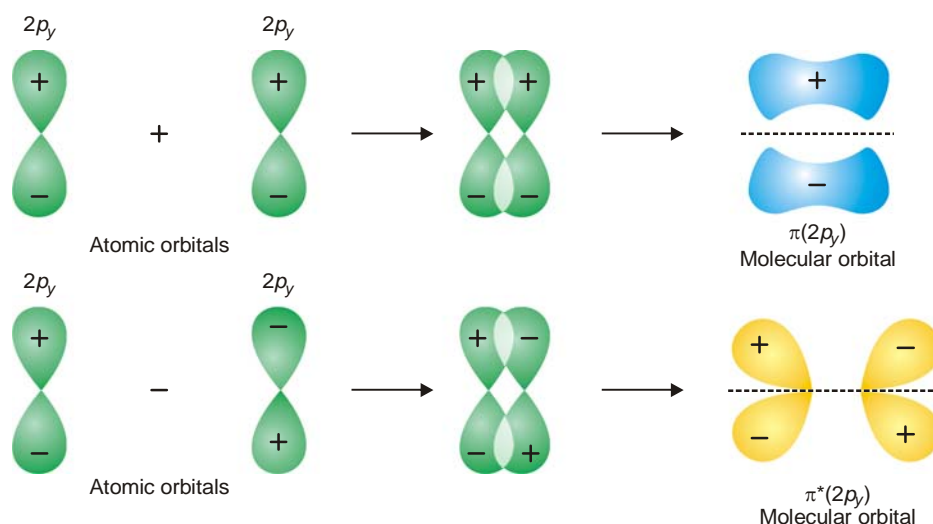

■ **Figure 6.32**

**Formation of bonding and antibonding molecular orbitals by side-wise overlap of  $2p_y$  atomic orbitals.  $2p_x$  Orbitals also combine in the similar way.**

Since we are concerned here with few simple molecules, the only molecular orbitals which need to be considered are

$$\text{Bonding MOs} = \sigma(1s) \sigma(2s) \sigma(2p_z) \pi(2p_y) \pi(2p_x)$$

$$\text{Antibonding MOs} = \sigma^*(1s) \sigma^*(2s) \sigma^*(2p_z) \pi^*(2p_y) \pi^*(2p_x)$$

They are arranged in their increasing order of energy as determined by spectroscopic measurements. It is clear from Fig. 6.33 that the three  $2p$  atomic orbitals of isolated atoms are all degenerate but this degeneracy splits in the molecular orbitals. The  $\sigma(2p_z)$  bonding molecular orbital has a lower energy than either of the remaining two degenerate  $\pi$  bonding molecular orbitals  $-\pi(2p_y)$  and  $\pi(2p_x)$ . For diatomic molecules obtained from atom having more than one electronic shell, the inner shells do not appreciably affect the bonding and may be omitted. Such inner electrons are called Non-bonding electrons. Electronic structures of simple molecules can be worked out by feeding electrons in the molecular orbitals in the order of increasing energy. Here also Aufbau principle—feeding electrons in the increasing order of energy of orbitals repeats itself. This order shown in Fig. 6.33 may be written as :

$$\sigma(1s) \sigma^*(1s) \sigma(2s) \sigma^*(2s) \sigma(2p_z) \pi(2p_y) = \pi(2p_x) \pi^*(2p_y) = \pi^*(2p_x) \sigma^*(2p_z)$$



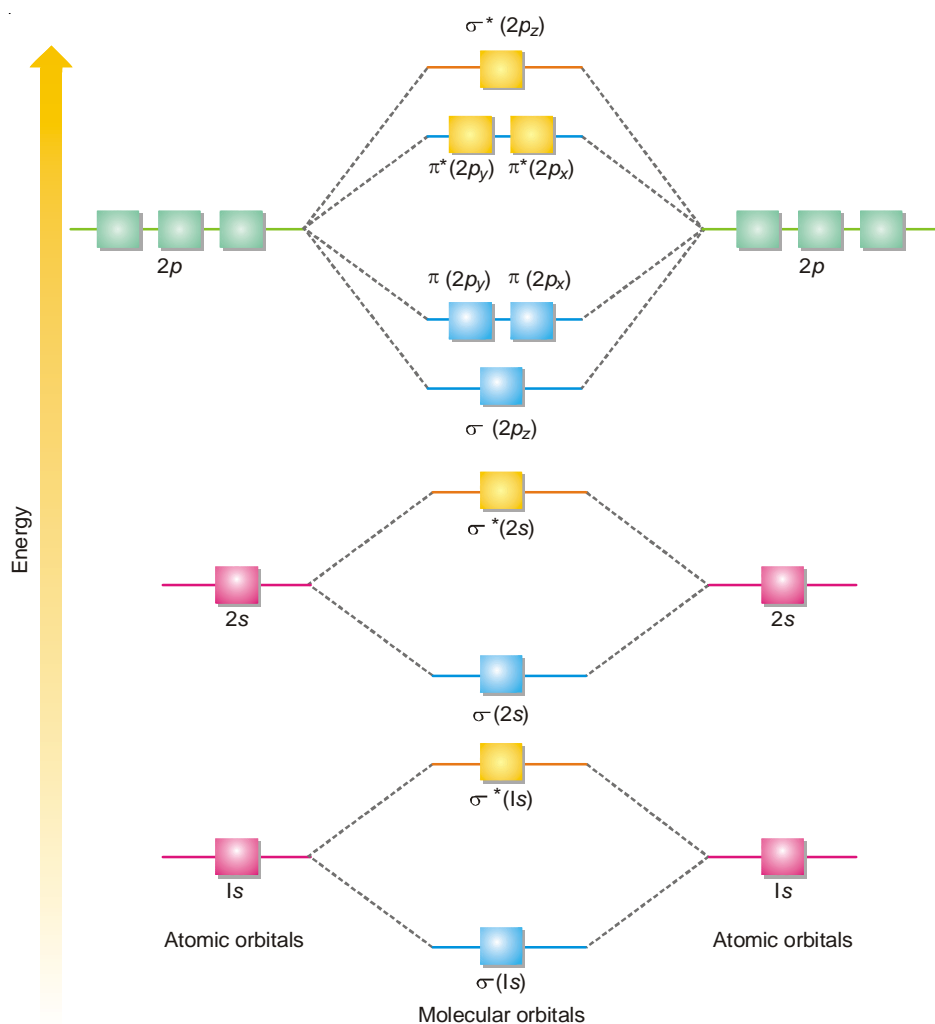

■ **Figure 6.33**  
Schematic energy level representation of molecular orbitals for simple molecules of elements.

### Conditions for the combination of Atomic Orbitals

The atomic orbitals may combine when certain conditions are met with. For effective combinations of atomic orbitals following are the conditions.

(1) **The energies of atomic orbitals should be comparable.** For homonuclear diatomic molecules of the type  $X_2$  similar atomic orbitals combine *i.e.*  $1s$  orbital of one atom combines with  $1s$  orbital of another and similarly  $2s$  orbital combines with  $2s$  orbital of another atom and so on. This means that  $1s$  orbital cannot combine with  $2s$  orbital because of large energy difference between the two orbitals. In case homonuclear molecules this condition may not be valid.

(2) **The extent of overlap between the atomic orbitals should be to a considerable extent.** Greater the overlap between the atomic orbitals, greater is charge density between the nuclei.

(3) **The symmetry of the combining atomic orbitals should be the same.** The atomic orbitals should have the same symmetry about the internuclear axis. For example,  $2s$  orbital of one atom can combine with  $2s$  or  $2p_z$  orbital of another atom but not with the  $2p_y$  or  $2p_x$  orbital. In other words

++ or -- interaction is allowed. It is made clear in the following diagram :

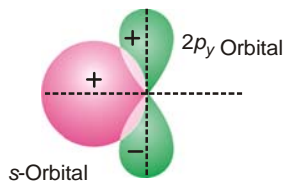

s-Orbital does not combine with  $2p_y$  orbital because they do not have the same symmetry about the internuclear axis.

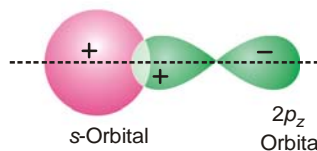

s-Orbital combines with  $2p_z$  orbital as they have same symmetry about the internuclear axis.

### Allowed Combinations of Atomic orbitals

Due to symmetry reasons allowed combinations of atomic orbitals are given in Table 6.1.

TABLE 6.1. ALLOWED COMBINATIONS OF ATOMIC ORBITALS		
1st Orbital	2nd Orbital	Type of MO formed
s-orbital	s-orbital	$\sigma$ (Sigma)
s-orbital	$p_z$ -orbital	$\sigma$ (Sigma)
$p_z$ -orbital	$p_z$ -orbital	$\sigma$ (Sigma)
$p_y$ -orbital	$p_y$ -orbital	$\pi$ (pi)
$p_x$ -orbital	$p_x$ -orbital	$\pi$ (pi)

### Energy Levels of Molecular orbitals

We have already discussed that the energy of a bonding MO is lesser than that of atomic orbital whereas the energy of an antibonding MO is higher than the atomic orbitals from which it has been formed. This was shown in Fig. 6.30 for hydrogen molecule.

The total energy of a diatomic molecule can also be plotted against the internuclear distance between its atoms. When these two atoms are brought closer the energy changes are shown in Fig. 6.34.

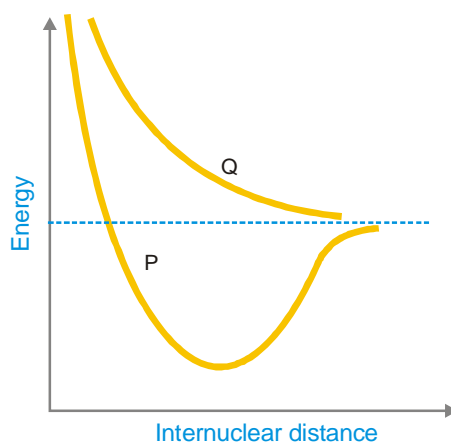

■ **Figure 6.34**  
Plot of energy of diatomic molecules versus internuclear distance.

The curve  $P$  represents the formation of a bonding molecular orbital and the curve  $Q$  represents the formation of an antibonding molecular orbital. It is clear from the curve  $Q$  that repulsive forces dominate during the formation of an antibonding molecular orbital. During the formation of a bonding molecular orbital the energy starts decreasing and reaches to a minimum value which corresponds to the bond length between the two atoms ( $r_0$ ). At a distance less than  $r_0$  the repulsive forces start dominating over the attractive forces and energy starts increasing.

### Difference Between Bonding and Antibonding Molecular Orbitals

The difference between bonding and antibonding orbitals is summarised below :

**TABLE 6.2. DIFFERENCE BETWEEN BONDING AND ANTIBONDING MOLECULAR ORBITALS**

Bonding MO	Antibonding MO
1. It is formed by <b>addition</b> overlap of atomic orbitals.	1. It is formed by <b>subtraction</b> overlap of atomic orbitals.
2. The wave function of a bonding MO is given by $\Psi_{(MO)} = \Psi_A + \Psi_B$	2. The wave function of an antibonding MO is given by $\Psi^*_{(MO)} = \Psi_A - \Psi_B$
3. Its formation takes place when the lobes of atomic orbitals have <b>same</b> signs.	3. Its formation takes place when the lobes of atomic orbitals have <b>different</b> signs.
4. The energy of bonding MO is <b>lower</b> than that of atomic orbitals from which it is formed.	4. The energy of antibonding MO is <b>higher</b> than that of atomic orbitals from which it is formed.
5. The electron density is <b>high</b> in the region between the nuclei of bonded atoms.	5. The electron density is <b>low</b> in the region between the nuclei of bonded atoms.
6. Every electron in bonding MO contributes towards the <b>attractive force</b> .	6. Every electron in antibonding contributes towards <b>repulsive force</b> .

### Combination of $s$ and $p_z$ -orbitals

$s$  and  $p_z$ -orbitals can also combine in a similar way along internuclear axis to form bonding and antibonding molecular orbitals as shown in Fig. 6.35.

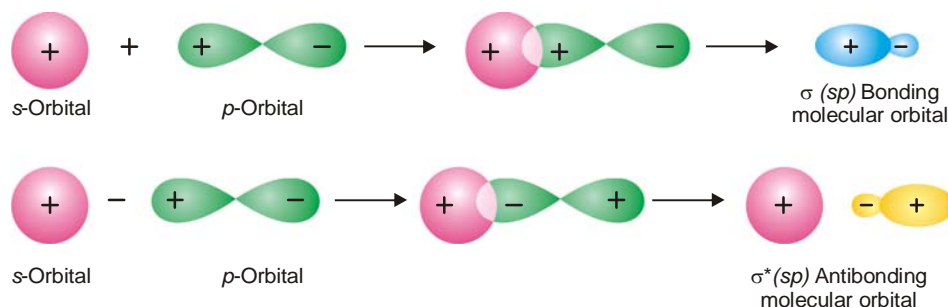

**Figure 6.35**

Formation of bonding and antibonding orbitals by the combination of  $s$  and  $p_z$  orbitals.

### Difference between Sigma and Pi molecular orbitals

The main points of difference between sigma and Pi molecular orbitals can be summed up in the Table 6.3.

TABLE 6.3. DIFFERENCE BETWEEN SIGMA AND PI MOLECULAR ORBITALS

Sigma ( $\sigma$ ) MO	Pi ( $\pi$ ) MO
1. It is formed by <b>head to head</b> overlapping of atomic orbitals.	1. It is formed by the <b>sidewise</b> overlapping of $p_y$ or $p_x$ atomic orbitals.
2. The overlap is <b>along internuclear axis</b> .	2. The overlap is <b>perpendicular</b> to <b>internuclear axis</b> .
3. As a result of this <b>strong</b> bond is formed.	3. As a result of this <b>weak</b> bond is formed.
4. This orbital is <b>symmetrical to rotation</b> about the line joining the two nuclei.	4. This orbital is <b>not symmetrical to rotation</b> about the line joining the two nuclei.
5. The region of overlap is <b>greater</b> .	5. The region of overlap is <b>lesser</b> .

### BOND ORDER

How many are the bonds in a molecule or **Bond order** is correctly predicted by the Molecular Orbital theory. The number of bonds in a molecule is one-half of the difference of the number of electrons in the bonding molecular orbitals and the number of electrons in the antibonding molecular orbitals. Mathematically,

$$\text{Bond order} = \frac{\left( \text{No. of electrons in bonding orbitals} \right) - \left( \text{No. of electrons in antibonding orbitals} \right)}{2} = \frac{N_b - N_a}{2}$$

In common practice, only MOs formed from valence orbitals are considered for determining bond order.

The predicted bond orders are found to be in conformity with other methods of determining it. Thus Molecular Orbital theory helps in establishing whether the existence of a bond is feasible or not. For instance, the formation of  $\text{He}_2$  molecule, discussed in the following section, is completely ruled out as the bond order predicted is zero.

In general,

- (a) A molecule is stable if  $N_b > N_a$
- (b) A molecule is unstable if  $N_b < N_a$

### Information given by Bond order

The bond order as determined by the above formula is very helpful as it gives us the following valuable information :

#### (1) Stability of the Molecule/Ion

A molecule/ion is stable if  $N_b > N_a$

#### (2) Bond Dissociation Energy

It depends upon the bond order. Greater the bond order greater is the bond dissociation energy.

#### (3) Bond Length

Bond order is inversely proportional to the bond length. Higher the bond order, smaller the bond length.

#### (4) Magnetic Properties

The presence of unpaired electrons in Molecular orbitals of a species makes it paramagnetic in nature. Greater the number of unpaired electrons, the more will be its paramagnetic character. On the other hand, if there are no unpaired electrons in MOs the species will be diamagnetic in nature.

### HOMONUCLEAR DIATOMIC MOLECULES

After having discussed the basic principles of Molecular Orbital theory, we are now able to take up the electronic structures and bonding properties of some of the homonuclear diatomic molecules.

#### (1) Hydrogen, $H_2$

Hydrogen molecule is formed from  $1s^1$  atomic orbitals of two atoms. They give rise to two molecular orbitals  $\sigma(1s)$  and  $\sigma^*(1s)$ . The molecule has two electrons to be accommodated in these two molecular orbitals and are filled as desired by Aufbau order of filling. Both these electrons go to the lower energy bonding molecular orbital and the antibonding orbital remains vacant. The electronic configuration of the molecule is represented by the equation :



The number of bonds in the molecule, accordingly is  $= \frac{1}{2}(2 - 0) = 1$ . Thus two hydrogen atoms are bonded through only one bond in the molecule.

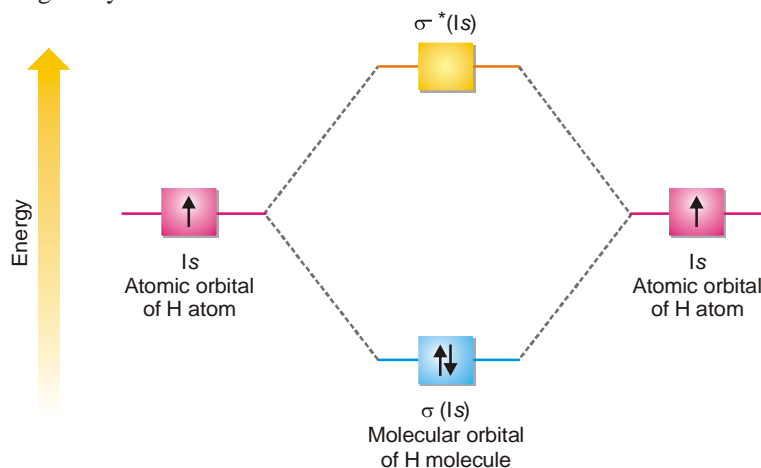

■ **Figure 6.36**  
Molecular orbital diagram of  $H_2$  molecule.

#### (2) Helium, $He_2$

Helium atoms have the configuration  $1s^2$ . For the formation of  $He_2$ , the molecular orbitals required are  $\sigma(1s)$  and  $\sigma^*(1s)$  which have to accommodate four electrons (two each contributed by the atoms). Each one of these molecular orbitals would accommodate two electrons as shown below.

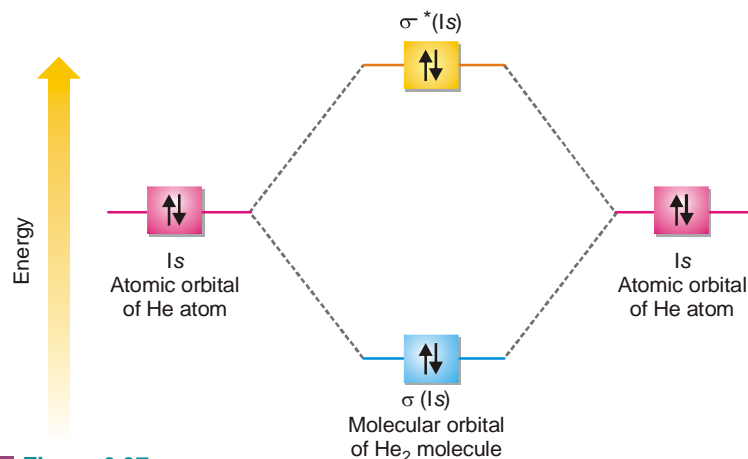

■ **Figure 6.37**  
Molecular orbital diagram of  $He_2$  molecule.

The molecule of helium is represented by the equation,



There are two electrons in each of the bonding and antibonding orbitals giving zero as the number of bonds,  $\frac{1}{2}(2 - 2) = 0$  *i.e.*, this molecule does not exist.

### (3) Lithium, $\text{Li}_2$

Lithium atom has one electron in the valence shell  $2s^1$ , the other electrons are non-bonding. Two such atoms give a molecule having two molecular orbitals  $\sigma(2s)$  and  $\sigma^*(2s)$  and only two electrons are to be filled in them. These are accommodated in the molecular bonding orbital while the antibonding molecular orbital remains vacant. The number of bonds =  $\frac{1}{2}[(2 - 0)] = 1$  *i.e.*, two lithium atoms form a molecule involving a single covalent bond. The bond energy is about  $25 \text{ kcal mole}^{-1}$  which is much less than of  $\text{H}_2$  molecule ( $103 \text{ kcal mole}^{-1}$ ).

### (4) Beryllium, $\text{Be}_2$

Diatomic beryllium molecule is not formed because two valence electrons present as  $2s^2$  in Be atoms give two molecular orbitals  $\sigma(2s)$  and  $\sigma^*(2s)$ , each having two electrons. The equation representing the formation is,

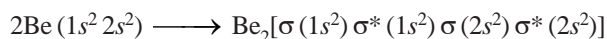

The number of bonds =  $\frac{1}{2}(2 - 2) = 0$ .

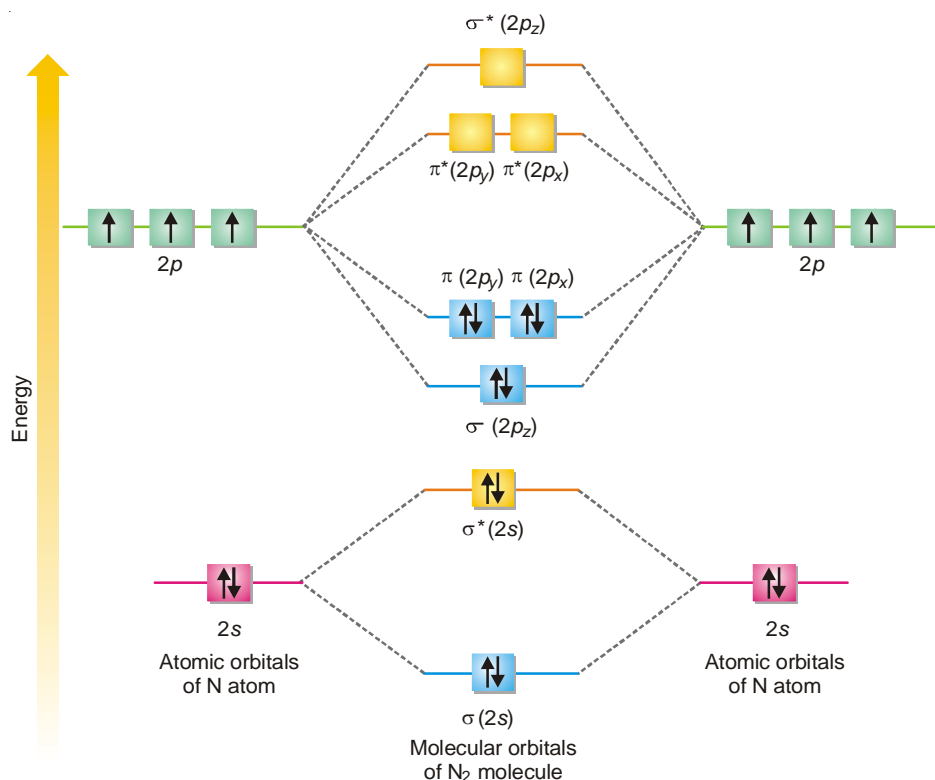

■ **Figure 6.38**  
Filling of molecular orbitals of  $\text{N}_2$  molecule;  
three anitbonding orbitals are vacant.

**(5) Nitrogen, N<sub>2</sub>**

Each of the two N-atoms ( $1s^2, 2s^2, 2p_x^1, 2p_y^1, 2p_z^1$ ) contribute,  $(2 + 1 + 1 + 1) = 5$  valence electrons and four atomic orbitals towards the molecule. The molecule would have eight molecular orbitals and ten electrons to be accommodated in them. The electronic configuration in the molecule is represented as given in Fig. 6.38.

There are eight electrons in the bonding molecular orbitals and only two in antibonding orbital. This gives the number of bonds  $\frac{1}{2} (8 - 2) = 3$ . The two N atoms are bonded with three covalent bonds *i.e.*, a triple bond. N<sub>2</sub> molecule is diamagnetic as it has no unpaired electron.

**(6) Oxygen, O<sub>2</sub>**

The two participating oxygen atoms ( $1s^2, 2s^2, 2p_x^2, 2p_y^1, 2p_z^1$ ) contribute a total of  $2(2 + 2 + 1 + 1) = 12$  valence electrons and  $2 \times 4 = 8$  atomic orbitals towards the oxygen molecule. There are eight molecular orbitals and 12 electrons are accommodated as shown in Fig. 6.39.

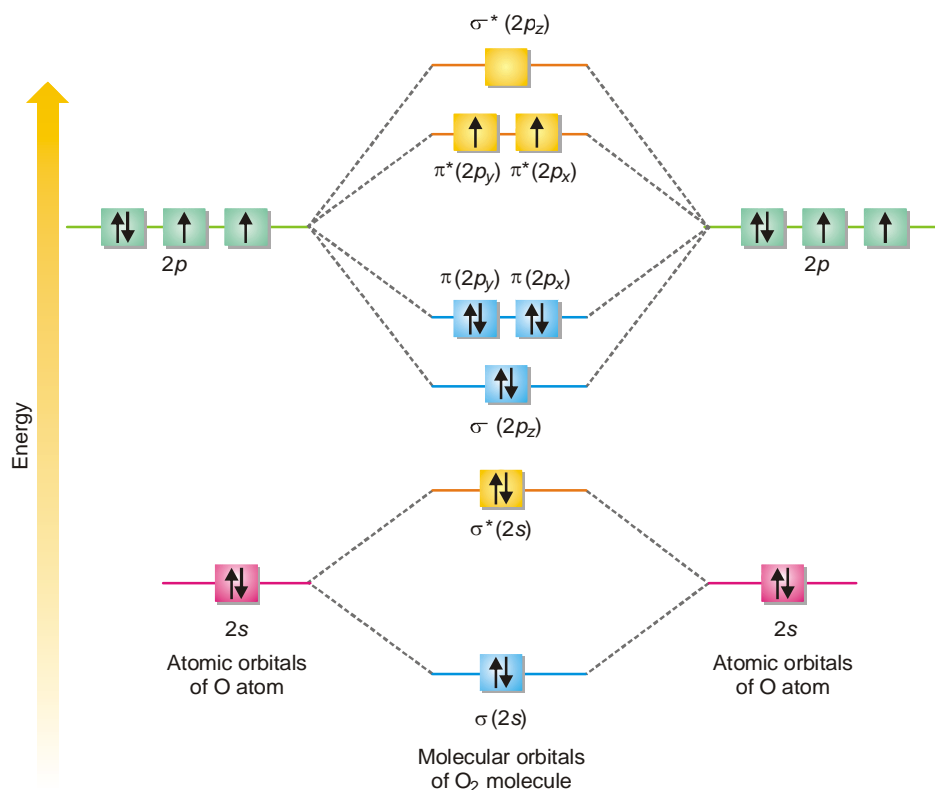

■ **Figure 6.39**

**Molecular orbitals of O<sub>2</sub> molecule, having one full, two half-filled and one vacant antibonding orbitals; and all the bonding molecular orbitals are full.**

We find from Fig. 6.39 on previous page that Aufbau order of filling of molecular orbital leaves two unpaired electrons in each of degenerate  $\pi_y^*(2p_y)$  and  $\pi_z^*(2p_x)$  orbitals. The electronic configuration of the molecular orbitals accounts admirably for the paramagnetic behaviour of oxygen molecule. It is the lone electron that creates a magnetic field around it due to its spin. But if there are two electrons spinning near each other in opposite directions *i.e.*, with their spins paired,

the magnetic fields created by these electrons cancel each other. However, if the electrons spin in the same direction, the total magnetic field would be the sum of the fields of each of the two electrons. This situation prevails in oxygen molecule and the experimentally established extent or magnitude of paramagnetism is consistent with two unpaired electrons per molecule. This is the greatest success of the Molecular Orbital theory. The number of bonds in  $O_2$  molecules =  $\frac{1}{2}(8 - 4) = 2$ .

Proceeding on these lines, the electronic configurations of other simple species like  $O_2^-$ ,  $O_2^+$  can be worked out. The electronic configuration, bond order and magnetic character of these species is summed in the Table 6.4.

**TABLE 6.4. ELECTRONIC CONFIGURATION, BOND ORDER AND MAGNETIC CHARACTER OF  $O_2^+$ ,  $O_2^-$  AND  $O_2^{2-}$**

Species	No. of valence Electrons	Electronic Configuration	Bond Order	Magnetic Character
$O_2^+$	11	$KK \sigma(2s)^2 \sigma^*(2s)^2, \sigma(2p_z)^2$ $\pi(2p_y)^2 \pi(2p_x)^2, \pi^*(2p_y)^1$	$\frac{8-3}{2} = 2.5$	Paramagnetic
$O_2^-$	13	$KK \sigma(2s)^2 \sigma^*(2s)^2, \sigma(2p_z)^2$ $\pi(2p_y)^2 \pi(2p_x)^2, \pi^*(2p_y)^2 \pi^*(2p_x)^1$	$\frac{8-5}{2} = 1.5$	Paramagnetic
$O_2^{2-}$	14	$KK \sigma(2s)^2 \sigma^*(2s)^2, \sigma(2p_z)^2$ $\pi(2p_y)^2 \pi(2p_x)^2, \pi^*(2p_z)^2 \pi^*(2p_x)^2$	$\frac{8-6}{2} = 1$	Diamagnetic

### (7) Fluorine ( $F_2$ )

The two participating F atoms ( $1s^2, 2s^2, 2p_x^2, 2p_y^2, 2p_z^1$ ) contribute a total of 14 valence electrons and there are eight molecular orbitals towards  $F_2$  molecule formed from two F atoms having four atomic orbitals each. In these MOs 14 electrons are accommodated. The electronic configuration of  $F_2$  molecule is

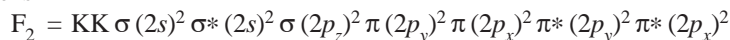

The bond order in  $F_2$  molecule is

$$= \frac{N_b - N_a}{2} = \frac{8 - 6}{2} = 1$$

Since  $F_2$  molecule has no unpaired electron, it is diamagnetic in nature. The molecular orbital diagram of  $F_2$  molecule is shown in Fig. 6.40.

### (8) Neon Molecule ( $Ne_2$ )

The electronic configuration of Ne is  $1s^2 2s^2 2p^6$ . There are 16 valence electrons belonging to both neon atoms. There are 8 MOs which have to accommodate 16 valence electrons. The electronic configuration of  $Ne_2$  molecule is given below :

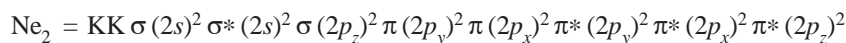

The bond order =  $N_b - N_a$

$$= \frac{8 - 8}{2} = 0$$

Since no bond is formed between two Ne atoms, this molecule does not exist.



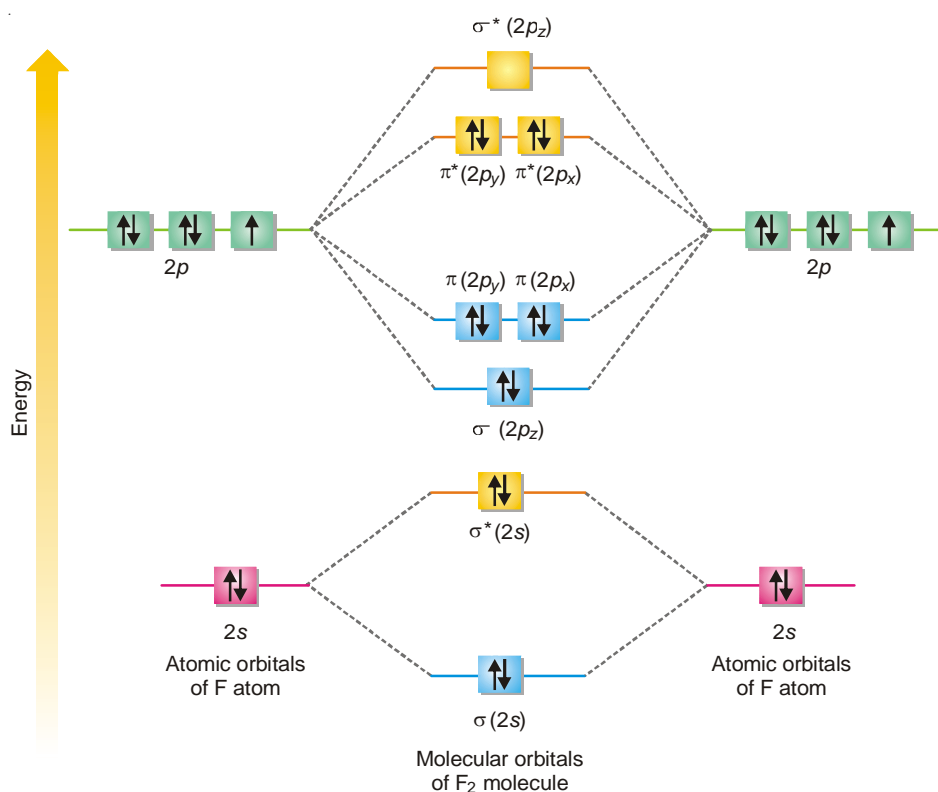

■ **Figure 6.40**  
Molecular orbital diagram of  $F_2$  molecule.

### HETERONUCLEAR DIATOMIC MOLECULES

When two different atoms are bonded together, their molecule is called heteronuclear molecule. The same general principle applies to heteronuclear molecules but the main difference is that in heteronuclear molecule different atoms contribute unequally to the wave function *i.e.*

$$\Psi_{MO} = C_1 \psi_1 AO + C_2 \psi_2 AO$$

where  $C_1$  and  $C_2$  are two constants having different values for different atoms. Also the molecular orbitals formed are unsymmetrical due to difference in electronegativities. In the construction of Molecular Orbital diagrams for heteronuclear molecules the bonding MOs are shown closer to electronegative atoms while antibonding MOs are shown closer to lesser electronegative atom.

It may be noted if two different molecules have the same total number of electrons their molecular energy diagram will be similar.

Let us now construct the molecular energy diagram for some heteronuclear molecules.

#### (1) Nitric Oxide (NO)

The electronic configuration of participating N and O atoms are

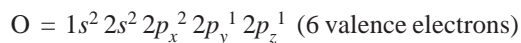
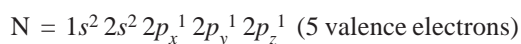

The total number of valence electrons is 11 and electronic configuration of NO molecule can be written as

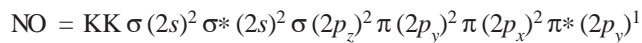

$$\begin{aligned} \text{The bond order} &= \frac{1}{2} N_b - N_a \\ &= \frac{1}{2} (8 - 3) \\ &= 2\frac{1}{2} \\ &= 2.5 \end{aligned}$$

It makes clear that one  $\sigma$  bond and two pi bonds with an unpaired electron in antibonding  $\pi^*$  ( $2p_y$ )<sup>1</sup> molecular orbital are formed. This molecule is less stable than  $\text{N}_2$  molecule (Bond order = 3). Due to the presence of one unpaired electron in NO molecule it is paramagnetic in nature.

The MO diagram for NO molecule is shown in Fig. 6.41.

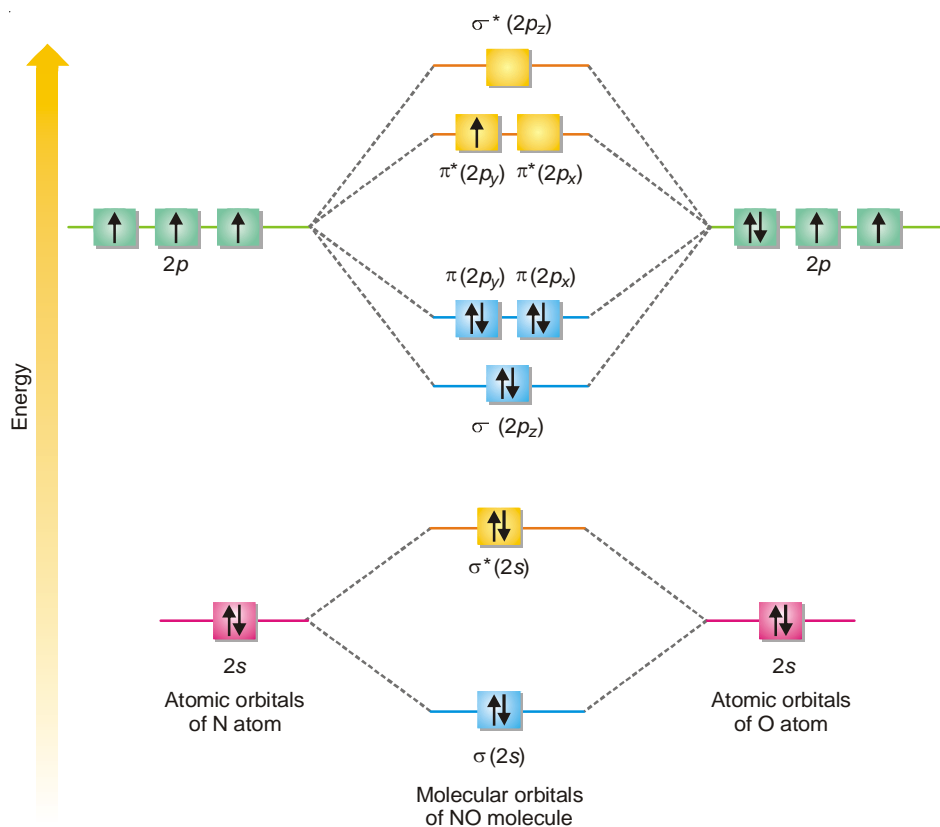

■ **Figure 6.41**  
Molecular orbital diagram of NO molecule.

## (2) $\text{NO}^+$ and $\text{NO}^-$ Ions

On similar lines we can write the electronic configuration, bond order and magnetic character of these ions. These are summarised in Table 6.5.

**TABLE 6.5.** Electronic configuration, Bond order and Magnetic character of NO<sup>+</sup> and NO<sup>-</sup> ions.

Species	No. of Electrons	Electronic Configuration	Bond Order	Magnetic Character
NO <sup>+</sup>	14	KK $\sigma(2s)^2 \sigma^*(2s)^2 \sigma(2p_z)^2$ $\pi(2p_y)^2 \pi(2p_x)^2$	$\frac{8-2}{2} = 3$	Diamagnetic
NO <sup>-</sup>	16	KK $\sigma(2s)^2 \sigma^*(2s)^2 \sigma(2p_z)^2$ $\pi(2p_y)^2 \pi(2p_x)^2$ $\pi^*(2p_y)^1 \pi^*(2p_x)^1$	$\frac{8-4}{2} = 2$	Paramagnetic

### (3) Carbon Monoxide (CO)

The electronic configurations of participating C and O atoms are

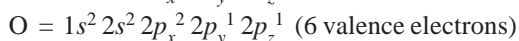
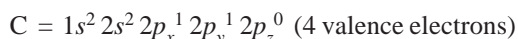

The total number of valence electrons is 10 and the electronic configuration of CO molecule can be written as

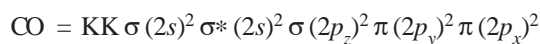

$$\text{The bond order} = \frac{N_b - N_a}{2} = \frac{1}{2} (8 - 2) = 3$$

This shows that carbon and oxygen atom in CO are bonded to each other by a triple bond (one  $\sigma$  bond and two  $\pi$  bonds). There is no unpaired electron in CO molecule and hence it is diamagnetic in nature. The molecular orbital diagram for CO molecule is shown in Fig. 6.42.

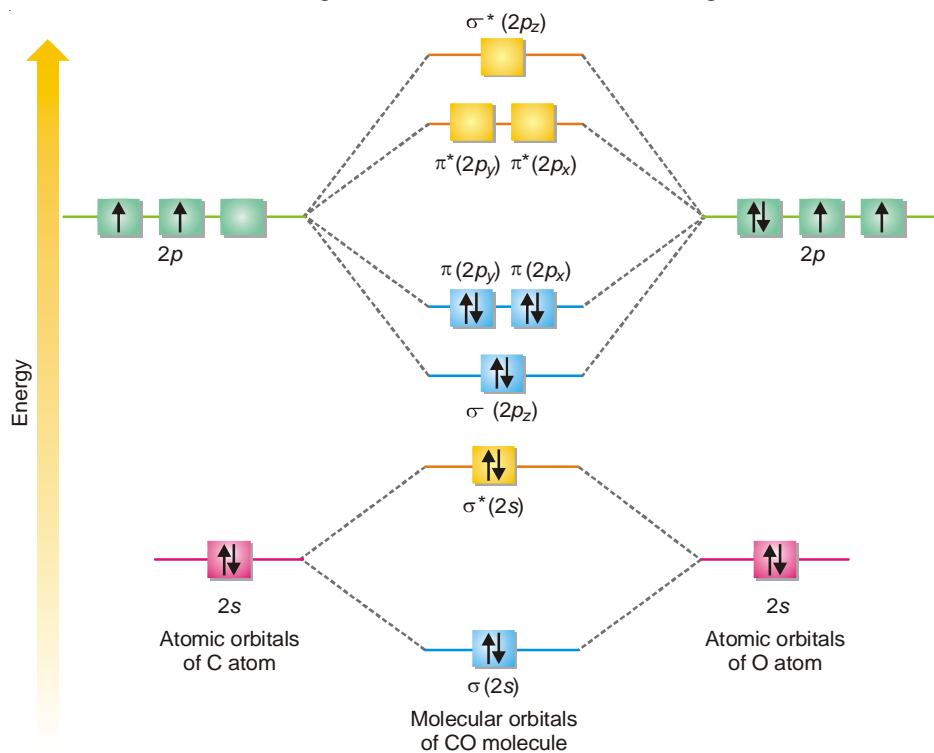

■ **Figure 6.42**  
Molecular orbital diagram of CO molecule.

**(4) CN Molecule**

The electronic configuration of participating C and N atoms are

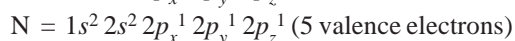
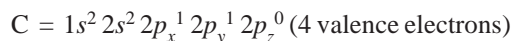

The total number of valence electrons is 9 and the electronic configuration of CN molecule can be written as

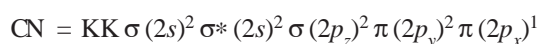

$$\text{The bond order} = \frac{1}{2} (N_b - N_a) = \frac{1}{2} (7 - 2) = 2 \frac{1}{2}$$

Since the bond order in CN molecule is lesser than CO molecule, the former is less stable than the latter. Also, there is one unpaired electron in CN molecule. It is paramagnetic in nature. The molecular orbital diagram of CN molecule is shown in Fig. 6.43.

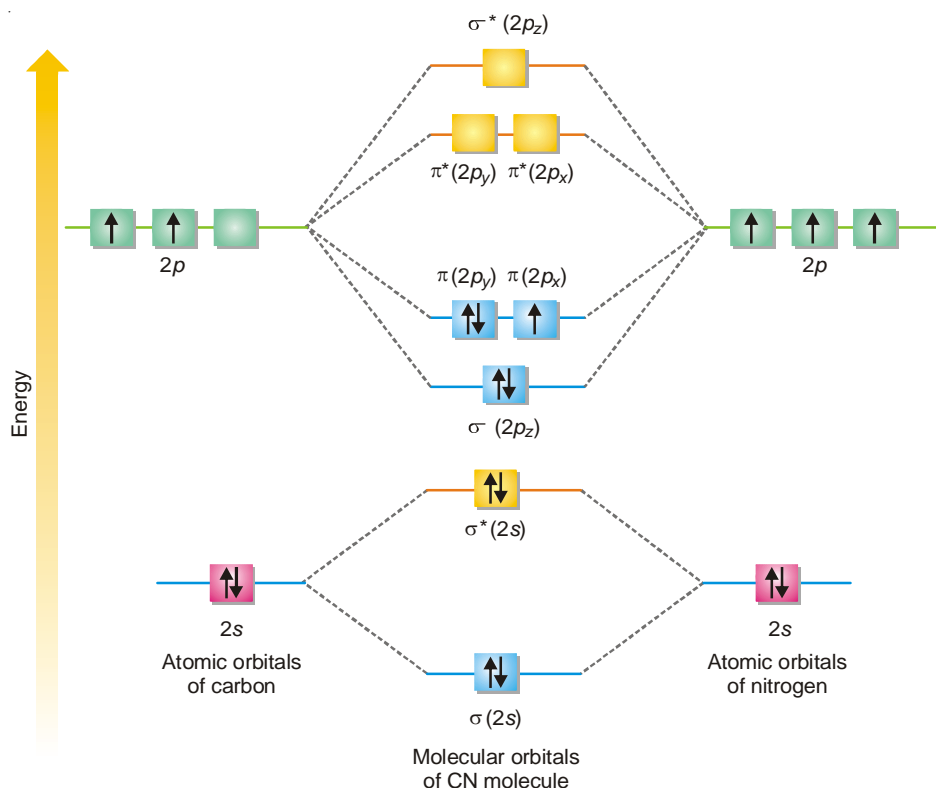

■ **Figure 6.43**  
Molecular orbital diagram of CN molecule.

**EXAMINATION QUESTIONS**

1. Define or explain the following terms :

(a) Hybridization

(b) Bonding molecular orbital

(c) Anti-bonding molecular orbital

(d) Bond order

2. What is meant by hybridization? Write the hybridisation involved in (i) Beryllium dichloride and (ii) Boron trifluoride.
  3. The molecules of  $\text{CH}_4$  (methane),  $\text{NH}_3$  (Ammonia) and  $\text{H}_2\text{O}$  (water) all involve  $sp^3$  hybridization of the central atom but the bond angles in these molecules are  $109^\circ 28'$ ,  $107^\circ 18'$  and  $104^\circ 30'$  respectively. Explain.
  4. Explain the following on the basis of molecular orbital theory :
    - (a)  $\text{Br}_2$  molecule is not stable
    - (b)  $\text{N}_2$  has a stronger bond than  $\text{B}_2$
    - (c)  $\text{F}_2$  is diamagnetic while  $\text{O}_2$  is paramagnetic
  5. Explain clearly the concept of hybrid bond orbitals and show how it gives a better description of the geometry of molecules.
  6. (a) What is a molecular orbital? In what ways is a molecular orbital different from a valence bond orbital?  
 (b) Sketch and describe the molecular orbital resulting from the following overlaps of atomic orbitals:
    - (i) Two  $s$ -orbitals
    - (ii) Head-on overlap of two  $p$ -orbitals
  7. (a) What is hybridization? Write down the rules for hybridization of orbitals.  
 (b)  $\text{CH}_4$ ,  $\text{NH}_3$  and  $\text{H}_2\text{O}$  have tetrahedral geometry yet their bond angles are different. Why?
  8. Describe  $sp^3$ ,  $sp^2$  and  $sp$  hybridization of carbon in organic molecules. Draw the model of acetylene and label the bonds as sigma ( $\sigma$ ) and pi ( $\pi$ ) bonds.
  9. (a) Indicate the type of hybridization of C atoms in  $\text{CH}_2 = \text{C}^* = \text{C}^*\text{H}_2$   
 (b) Draw the molecular orbital structure of oxygen molecule and answer the following :
    - (i) How many bonding and anti-bonding orbitals are there in the molecule?
    - (ii) How many unpaired electrons are there?
    - (iii) How many  $\sigma$  and  $\pi$  bonds are there?
 (c) Draw the formation of
    - (i) three  $sp^2$  hybrid orbitals and
    - (ii) orbital structure of acetylene
    - (iii) Why is the shape of methane molecule tetrahedral?
  10. (a) Explain the terms bonding and molecular orbitals with examples.  
 (b) Explain with the help of MO theory, the paramagnetic character of oxygen.
  11. (a) What are  $\sigma$  and  $\pi$  molecular orbitals and give their characteristics?  
 (b) Explain the formation of HF molecule with MO diagram.
  12. Explain the state of hybridization of oxygen atom in water and indicate its shape.
  13. What is  $\pi$  bond? Explain the formation of  $\pi$  bond in ethylene and acetylene.
  14. What is meant by hybridization?
  15. Explain  $sp$ ,  $sp^2$  and  $sp^3$  hybridization with the help of simple organic molecules. Indicate the shape of the molecule in each case.
  16. Discuss with the help of M.O. theory, the formation of  $\text{N}_2$ ,  $\text{O}_2$  and  $\text{F}_2$  molecules? How does this theory explain the difference in reactivity of  $\text{N}_2$ ,  $\text{O}_2$  and  $\text{F}_2$  molecules?
  17. (a) Fill up the blanks :
    - (i) HF molecules are bonded through \_\_\_\_\_ bond.
    - (ii) The geometrical shape of  $\text{CH}_4$  molecule is \_\_\_\_\_
 (b) Explain the type of hybridization and geometrical shape of  $\text{PCl}_5$  molecule with the help of orbital diagram.  
 (c) Explain the shape of  $\text{NH}_3$  and  $\text{H}_2\text{O}$  with the help of VSEPR theory.
- Answer.** (a) (i) Hydrogen; (ii) Tetrahedral

18. (a) What are the characteristics of hybrid orbitals?  
 (b) What is tetrahedral hybridization? Explain the formation of C–H bonds in CH<sub>4</sub>.  
 (c) What are sigma ( $\sigma$ ) and pi ( $\pi$ ) bonds? Distinguish between them.
19. (a) Discuss the wave mechanical concept of covalent bond.  
 (b) What is meant by  $\pi$  bond?  
 (c) Give the electronic configuration of HCl molecule. Draw its energy level diagram.
20. (a) What is meant by hybrid orbital? On the basis of concept of hybridization how do you account for the observed H–O–H bond angle in water molecule?  
 (b) Compare the polarity character of the following pairs :  
 (i) NH<sub>3</sub> and NF<sub>3</sub> (ii) CO<sub>2</sub> and SO<sub>2</sub>
21. (a) Compare V.B.T. and M.O.T.  
 (b) Draw the molecular orbital picture of NO.  
 (c) What are the differences between bonding and antibonding molecular orbitals?  
 (d) Explain the structure of SF<sub>4</sub> on the basis of hybridization.
22. Write the molecular orbital configuration of C<sub>2</sub><sup>2-</sup> and calculate the bond order of the acetylide ion C<sub>2</sub><sup>2-</sup>  
**Answer.** Three
23. Write the molecular orbital configuration of O<sub>2</sub><sup>-</sup> ion.  
**Answer.** KK  $\sigma(2s^2) \sigma^*(2s^2) \sigma(2p_z^2) \pi(2p_y^2) \pi(2p_x^2) \pi^*(2p_y^1) \pi^*(2p_x^1)$
24. Write MO configuration for O<sub>2</sub> and O<sub>2</sub><sup>2-</sup> and which of them is paramagnetic?  
**Answer.** O<sub>2</sub> is paramagnetic
25. On the basis of bond order, predict which of the following species is the most stable?  
 O<sub>2</sub><sup>-</sup>, O<sub>2</sub> and Ne<sub>2</sub><sup>+</sup>  
**Answer.** O<sub>2</sub> is most stable
26. Write the ground state electronic configuration of O<sub>2</sub><sup>+</sup> on the basis of MO theory.  
**Answer.** KK  $\sigma(2s^2) \sigma^*(2s^2) \sigma(2p_z^2) \pi(2p_y^2) \pi(2p_x^2) \pi^*(2p_x^1)$
27. Which has greater bond dissociation energy N<sub>2</sub> or N<sub>2</sub><sup>+</sup>?  
**Answer.** N<sub>2</sub>, as it has bond order of three
28. Write the electronic configuration of Be<sub>2</sub> molecule and calculate its bond order.  
**Answer.** KK  $\sigma(2s^2) \sigma^*(2s^2)$ ; zero
29. Write the ground state electronic configuration of N<sub>2</sub><sup>-</sup> on the basis of MO theory and calculate its bond order.  
**Answer.** KK  $\sigma(2s^2) \sigma^*(2s^2) \sigma(2p_z^2) \pi(2p_y^2) \pi(2p_x^2) \pi^*(2p_x^1)$ ; 2.5
30. Calculate the number of antibonding electrons in O<sub>2</sub><sup>2-</sup> molecule on the basis of M.O. theory  
**Answer.** Four
31. (a) Why the bond angle in H<sub>2</sub>S is less than H<sub>2</sub>O?  
 (b) Explain the structure and hybridization of SO<sub>4</sub><sup>2-</sup> ion.  
 (c) Explain the structure and various bond angles in IF<sub>7</sub>.  
 (d) Why is the bond angle of OF<sub>2</sub> smaller than that of Cl<sub>2</sub>O?
32. Explain the structure of O<sub>2</sub> and N<sub>2</sub> molecules by M.O. theory. Show that O<sub>2</sub> is paramagnetic according to MO theory.
33. Account for the following with reasons :  
 (a) Melting point of MgCl<sub>2</sub> is much higher than that of AlCl<sub>3</sub>.  
 (b) KI is soluble in alcohol but KCl is not.
34. Write short notes on :  
 (a) Lattice Energy (b) Polarity of bonds (Agra BSc, 2000)
35. Explain why  $\sigma$  bond is stronger than  $\pi$  bond. (Madras BSc, 2000)

36. (a) What are the main differences between valence bond and molecular orbital theories?  
 (b) Discuss the main features of the molecular orbital approach in context of bond formation in diatomic molecules. *(Purvanchal BSc, 2001)*
37. Draw figures for  $p$ - $p$  axial and  $p$ - $p$  lateral overlap. *(Nagpur BSc, 2002)*
38. (a) Draw M.O. diagram of CO and show its bond order.  
 (b) Nitrogen molecule is diamagnetic while oxygen molecule is paramagnetic. Explain.  
 (c) Discuss the conditions for the combination of atomic orbitals to form M.O. *(Punjabi BSc, 2002)*
39. Differentiate between bonding and non-bonding molecular orbitals. Draw the molecular structure of  $N_2$ . *(Kanpur BSc, 2003)*
40. (a) What are the factors which influence the formation of an ionic bond.  
 (b) Draw M.O. diagram for CO and compare its stability with  $CO^+$ .  
 (c) Distinguish between bonding and anti-bonding molecular orbitals. *(Panjab BSc, 2003)*
41. Explain the structures of following pairs of molecules in terms of valence bond theory.  
 (i)  $BF_3$  and  $NH_3$  (ii)  $H_2O$  and  $H_2S$  *(Arunachal BSc, 2003)*
42. What do you understand by LCAO in molecular orbital theory? Differentiate bonding, anti-bonding and non-bonding molecular orbital. *(Arunachal BSc, 2004)*
43. Describe the valence bond theory proposed by Hietler-London for the formation of  $H_2$  molecule. *(Arunachal BSc, 2004)*
44. Write the electronic configuration of  $Be_2$  molecule and calculate its bond order.  
**Answer.**  $KK \sigma(2s^2) \sigma^*(2s^2)$ ; zero *(Baroda BSc, 2005)*
45. Write the ground state electronic configuration of  $N_2^-$  on the basis of MO theory and calculate its bond order.  
**Answer.**  $KK \sigma(2s^2) \sigma^*(2s^2) \sigma(2p_z^2) \pi(2p_y^2) \pi(2p_x^2) \pi^*(2p_y^1)$ ; 2.5 *(Jabalpur BSc, 2006)*
46. Calculate the number of antibonding electrons in  $O_2^{2-}$  molecule on the basis of M.O. theory.  
**Answer.** Four *(Banaras BSc, 2006)*

### MULTIPLE CHOICE QUESTIONS

1. When a chemical bond between two atoms is formed, the potential energy of the system  
 (a) decreases (b) increases  
 (c) remains the same (d) cannot be predicted  
**Answer.** (a)
2. According to valence bond theory, a bond between two atoms is formed when  
 (a) half filled atomic orbitals overlap (b) fully filled atomic orbitals overlap  
 (c) non-bonding atomic orbitals overlap (d) electrons of the two atoms overlap  
**Answer.** (a)
3. The axial overlap between the two orbitals leads to the formation of a  
 (a) sigma bond (b) pi bond  
 (c) multiple bond (d) none of these  
**Answer.** (a)
4. The free rotation about a bond exists when the bond is a  
 (a) sigma bond (b) pi bond  
 (c) double bond (d) hydrogen bond  
**Answer.** (a)
5. The strength of a bond depends upon  
 (a) free rotation about  $\sigma$  bond (b) extent of overlapping between the orbitals

- (c) resonance in the molecule (d) whether the overlap is axial or sidewise

**Answer.** (b)

6. In a  $N_2$  molecule there are  
 (a) one sigma and one pi bond (b) two sigma and one pi bond  
 (c) one sigma and two pi bonds (d) three sigma bonds

**Answer.** (c)

7. Out of the following, which statement is incorrect  
 (a) half filled orbitals only take part in hybridization  
 (b) the orbitals taking part in hybridization should have very little energy difference  
 (c) the number of hybrid orbitals formed is equal to the number of orbitals intermixed  
 (d) the energy of hybrid orbitals is less than that of atomic orbitals

**Answer.** (a)

8. When one  $s$  and two  $p$  orbitals hybridize we get  
 (a) three new orbitals at  $90^\circ$  to each other (b) three new orbitals at  $120^\circ$  to each other  
 (c) two new orbitals at  $180^\circ$  to each other (d) two new orbitals at  $90^\circ$  to each other

**Answer.** (b)

9. In  $sp^3$ ,  $sp^2$  and  $sp$  hybridized carbon atom the  $p$  character is maximum in  
 (a)  $sp^3$  (b)  $sp^2$   
 (c)  $sp$  (d) all have equal  $p$ -character

**Answer.** (a)

10. In  $H_2O$ ,  $NH_3$  and  $CH_4$  molecules the oxygen, nitrogen and carbon atom are  
 (a)  $sp^3$  hybridized (b)  $sp^3$ ,  $sp^2$  and  $sp$  respectively  
 (c)  $sp$ ,  $sp^2$  and  $sp^3$  respectively hybridized (d)  $sp^2$  hybridized

**Answer.** (a)

11.  $sp^3$  hybridization leads to  
 (a) trigonal geometry with bond angles  $120^\circ$  each  
 (b) tetrahedral geometry with bond angles  $109.5^\circ$  each  
 (c) tetrahedral geometry with bond angles  $90^\circ$  each  
 (d) square planar geometry with bond angles  $90^\circ$  each

**Answer.** (b)

12. In  $dsp^2$  hybridization, the new orbitals have the following geometry:  
 (a) square planar (b) tetrahedral  
 (c) trigonal (d) trigonal bipyramid

**Answer.** (d)

13. The shape of  $BF_3$  molecule is planar with bond angles equal to  $120^\circ$  each. It is due to  
 (a)  $sp^3$  hybridized B atom (b)  $sp^2$  hybridized B atom  
 (c)  $sp$  hybridized B atom (d)  $dsp^2$  hybridized B atom

**Answer.** (b)

14. The total number of orbitals taking part in  $sp$  hybridization in carbon atom is  
 (a) one (b) two  
 (c) three (d) four

**Answer.** (b)

15. A molecule of acetylene contains  
 (a) one  $\sigma$  and two  $\pi$  bonds (b) two  $\sigma$  and two  $\pi$  bonds  
 (c) three  $\sigma$  and two  $\pi$  bonds (d) two  $\sigma$  and three  $\pi$  bonds

**Answer.** (c)



16. In  $\text{PCl}_5$  molecule the phosphorus atom is  
(a)  $sp^3$  hybridized (b)  $sp^3d$  hybridized  
(c)  $sp^3d^2$  hybridized (d)  $sp^2$  hybridized  
**Answer.** (b)
17. Valence bond theory was proposed by  
(a) Rutherford (b) Neils Bohr  
(c) Heitler and London (d) Hund and Mulliken  
**Answer.** (c)
18. In the compound  $\text{HC}\equiv\text{C}-\text{C}^*\text{H}=\text{CH}_2$ ,  $\text{C}^*$  is  
(a)  $sp$  hybridized (b)  $sp^2$  hybridized  
(c)  $sp^3$  hybridized (d) none of these  
**Answer.** (b)
19. The carbon-carbon bond length is maximum in  
(a) ethane (b) ethene  
(c) ethyne (d) equal in all  
**Answer.** (a)
20. The carbon-hydrogen bond length is shortest in  
(a) ethane (b) ethene  
(c) ethyne (d)  $\text{CH}_4$   
**Answer.** (c)
21. In  $\text{SO}_2$  molecule, S atom is  
(a)  $sp^3$  hybridized (b)  $sp^2$  hybridized  
(c)  $sp$  hybridized (d)  $dsp^2$  hybridized  
**Answer.** (b)
22. The molecular orbitals formed as a result of LCAO method obey  
(a) Pauli's exclusion principle (b) Hund's rule of maximum multiplicity  
(c) Aufbau principle (d) all of these  
**Answer.** (d)
23. The energy of atomic orbitals taking part in molecular orbital formation  
(a) is equal to the molecular orbitals formed  
(b) is less than the molecular orbitals formed  
(c) is greater than the molecular orbitals formed  
(d) cannot be predicted  
**Answer.** (c)
24. A  $\text{He}_2$  molecule is not formed because  
(a)  $N_a > N_b$  (b)  $N_b = N_a$   
(c)  $N_b > N_a$  (d)  $N_b - N_a = +ve$   
**Answer.** (b)
25. A molecule or ion is stable if  
(a)  $N_b = N_a$  (b)  $N_b < N_a$   
(c)  $N_a < N_b$  (d)  $N_a - N_b = +ve$   
**Answer.** (c)
26. The bond order in  $\text{H}_2$  molecule as compared to  $\text{H}_2^+$  ion is  
(a) double (b) half  
(c) equal (d) cannot be predicted  
**Answer.** (a)

27. The bond order in  $\text{He}_2^+$  ion is  
 (a) 0.5 (b) 1.0  
 (c) 1.5 (d) 2.0  
**Answer.** (a)
28. In  $\text{O}_2$  molecule, the empty molecular orbital is  
 (a)  $\sigma$  ( $2s$ ) (b)  $\sigma^*$  ( $2s$ )  
 (c)  $\sigma$  ( $2p_z$ ) (d)  $\sigma^*$  ( $2p_z$ )  
**Answer.** (d)
29. The  $\text{O}_2$  molecule is paramagnetic. It can be explained on the basis of  
 (a) hybridization (b) valence bond theory  
 (c) molecular orbital theory (d) none of these  
**Answer.** (c)
30. The bond order in  $\text{O}_2^+$ ,  $\text{O}_2^-$  and  $\text{O}_2^{2-}$  respectively is  
 (a) 1, 1.5, 2.0 (b) 1.5, 2.0, 2.5  
 (c) 2.5, 1.5, 1 (d) 2.5, 1.0, 1.5  
**Answer.** (c)
31. Which among the species  $\text{O}_2^+$ ,  $\text{O}_2^-$ ,  $\text{O}_2$  and  $\text{O}_2^{2-}$  is diamagnetic  
 (a)  $\text{O}_2^+$  (b)  $\text{O}_2^-$   
 (c)  $\text{O}_2$  (d)  $\text{O}_2^{2-}$   
**Answer.** (d)
32. The diamagnetic species among  $\text{NO}^+$ ,  $\text{NO}$  and  $\text{NO}^-$  is  
 (a)  $\text{NO}^+$  (b)  $\text{NO}$   
 (c)  $\text{NO}^-$  (d) none of these  
**Answer.** (a)
33. The number of bonding and antibonding electrons respectively in  $\text{CO}$  molecule is  
 (a) 8, 2 (b) 2, 8  
 (c) 4, 2 (d) 2, 4  
**Answer.** (a)
34. Among  $\text{CO}$ ,  $\text{NO}$  and  $\text{CN}$  molecules, the one which contains no unpaired electrons and hence is diamagnetic  
 (a)  $\text{CO}$  (b)  $\text{NO}$   
 (c)  $\text{CN}$  (d) none of these  
**Answer.** (a)
35. The species with the highest bond order among  $\text{NO}$ ,  $\text{CO}$ ,  $\text{CN}$  and  $\text{O}_2$  is  
 (a)  $\text{NO}$  (b)  $\text{CO}$   
 (c)  $\text{CN}$  (d)  $\text{O}_2$   
**Answer.** (b)
36. Which one of the following has a zero bond order?  
 (a)  $\text{He}_2$  (b)  $\text{F}_2$   
 (c)  $\text{N}_2$  (d)  $\text{H-F}$   
**Answer.** (a)
37. Which among the following pairs are paramagnetic  
 (a)  $\text{O}_2$  and  $\text{N}_2$  (b)  $\text{O}_2$  and  $\text{CO}$   
 (c)  $\text{O}_2$  and  $\text{NO}$  (d)  $\text{CO}$  and  $\text{NO}$   
**Answer.** (c)

38. The bond order of a molecule is given by

- (a)  $\frac{N_a - N_b}{2}$  (b)  $\frac{N_b - N_a}{2}$   
 (c)  $\frac{N_b + N_a}{2}$  (d)  $\frac{N_a + N_b}{2}$

**Answer.** (b)

39. Oxygen molecule is paramagnetic because it has

- (a) less  $N_b$  than  $N_a$  (b) more  $N_b$  than  $N_a$   
 (c) all electrons are paired (d) unpaired electrons

**Answer.** (d)

40. The increasing bond order in the species  $O_2^-$ ,  $O_2^+$  and  $O_2^{2-}$  is

- (a)  $O_2^{2-} < O_2^+ < O_2^-$  (b)  $O_2^- < O_2^{2-} < O_2^+$   
 (c)  $O_2^{2-} < O_2^- < O_2^+$  (d)  $O_2^+ < O_2^- < O_2^{2-}$

**Answer.** (c)

41. The molecules which are iso-electronic among CO,  $N_2$ ,  $O_2$  and NO are

- (a)  $O_2$  and  $N_2$  (b)  $O_2$  and NO  
 (c)  $N_2$  and NO (d) CO and  $N_2$

**Answer.** (d)

42. The last electron in  $F_2$  molecule is present in M.O.

- (a)  $\sigma$  (2s) (b)  $\sigma^*$  (2s)  
 (c)  $\sigma^*$   $2p_z$  (d)  $\pi^*$   $2p_x$

**Answer.** (d)

43. The molecule  $Ne_2$  does not exist because

- (a)  $N_b > N_a$  (b)  $N_b = N_a$   
 (c)  $N_b < N_a$  (d) none of these

**Answer.** (b)

44. The molecule with the highest bond order among CO, CN, NO and  $O_2$  is

- (a) CO (b) CN  
 (c) NO (d)  $O_2$

**Answer.** (a)

45. Which of the following is not true regarding LCAO method

- (a) the energies of atomic orbitals should be comparable  
 (b) the atomic orbitals should overlap to a considerable extent  
 (c) the symmetry of the combining orbitals should be the same  
 (d) the energy of resulting antibonding orbital is less than that of bonding orbital

**Answer.** (d)

46. Which is not true about bonding MO?

- (a) it is formed by the addition overlap of atomic orbitals  
 (b) the wave function of a bonding MO is given by  $\Psi_{MO} = \Psi_A - \Psi_B$   
 (c) the lobes of atomic orbitals should have the same signs  
 (d) every electron in bonding MO contributes towards the attractive force

**Answer.** (b)